



prägeTECH

Schweizer Handwerk



Der Schnittkatalog für Plaketten, Medaillen und Pins

Vielfalt - Präzision - Leidenschaft

Entdecke das innovative Traditionshandwerk der Prägetech AG

01. Vorwort
02. Gestaltungsleitfaden
03. Einfachschnitte Plaketten Übersicht
04. Einfachschnitte Plaketten A4 (4:1)
05. Doppelschnitte Plaketten Übersicht
06. Einfachschnitte Pins Übersicht
07. Einfachschnitte Pins A4 (4:1)
08. Doppelschnitte Pins Übersicht
09. Gross- und Zugsplaketten
10. Befestigungsmöglichkeiten
11. Präsentations- und Verkaufshilfen
12. Innovative Lösungen - Bedruckt und Laserbeschriftet
13. Werbegadgets und Fanartikel



Impressum

Herausgeber:
Prägetech AG
Löhrweg 2a
CH-4442 Diepflingen
Telefon +41 61 481 00 22
info@praegetech.ch
www.praegetech.ch

Lieber Leser

Entdecken Sie in diesem Katalog alle Schnittformen, für die Gestaltung Ihrer Plakette, Medaille oder Ihres Abzeichens.

Wir sind der schweizer Ansprechpartner für innovation und Kreativität. Lassen Sie sich umfassend Beraten und entdecken Sie unsere Möglichkeiten von der Skizze über die Plakette weiter bis zur Verkaufshilfe.

Persönliche Beratung vor Ort

Termingerechte Auslieferung

Top Preis-Leistungsverhältnis

Prägen, Drucken, Systemlösungen

Produktionsstandort in der Schweiz

Jarzehntelange Erfahrung

Die Prägetech AG

Seit der Gründung im Jahre 1996 sind wir in der Herstellung von edlen und hochwertigen Fasnachtsplaketten, Medaillen, Münzen und Abzeichen tätig. Verarbeitet werden dabei hauptsächlich Kupfer und Messing, aber auch Neusilber, Aluminium und Kunststoffe.

In den letzten Jahren wurde aufgrund steigender Nachfrage das Leistungspaket der Firma ausgebaut. Nun stehen weitere Bereiche, wie z.B. das Drucken (Tampondruck) sowie das Systemgeschäft (Baugruppenmontage, Logistiklösungen usw.) für Sie zur Verfügung. – Dabei steht die «Leidenschaft

für Ihr Produkt» im Zentrum, sei dies beim Prägen, Stanzen, Gravieren, Drucken, Lackieren, Reinigen, Vergolden, Löten oder einem der vielen weiteren Herstellschritte.

Prägetech AG ist am Puls der Zeit und für Sie immer auf der Suche nach technischen und gestalterischen Innovationen. Unsere Produkte mit starken emotionalen und ausdrucksstarken Botschaften werden Sie überzeugen.

Mit Freude am Detail pflegen wir Schweizer Handwerk und produzieren für Sie in höchster Qualität. Fordern Sie uns jetzt heraus!



Was ist ein Schnittwerkzeug?

Schnittwerkzeuge sind vorgefertigte Stanzformen. Es können freie Formen gestanzt werden, sei es aus Metall, Kunststoff oder anderen Materialien.

Bei Prägetech AG stehen bereits viele Stanzformen zur Auswahl bereit. Diese können Sie als skalierbare Zeichnungen von unserer Website downloaden.

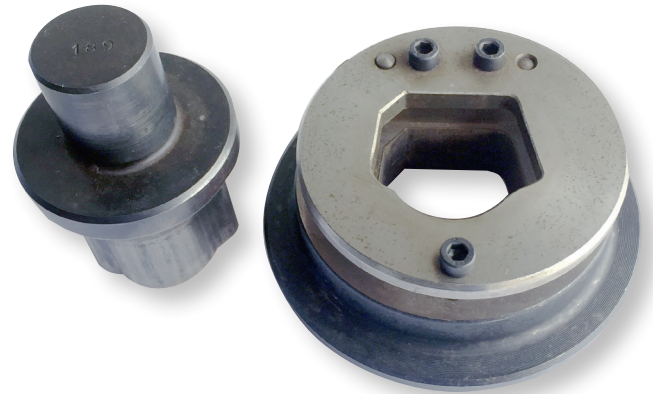

Stanzform Nr. 1189

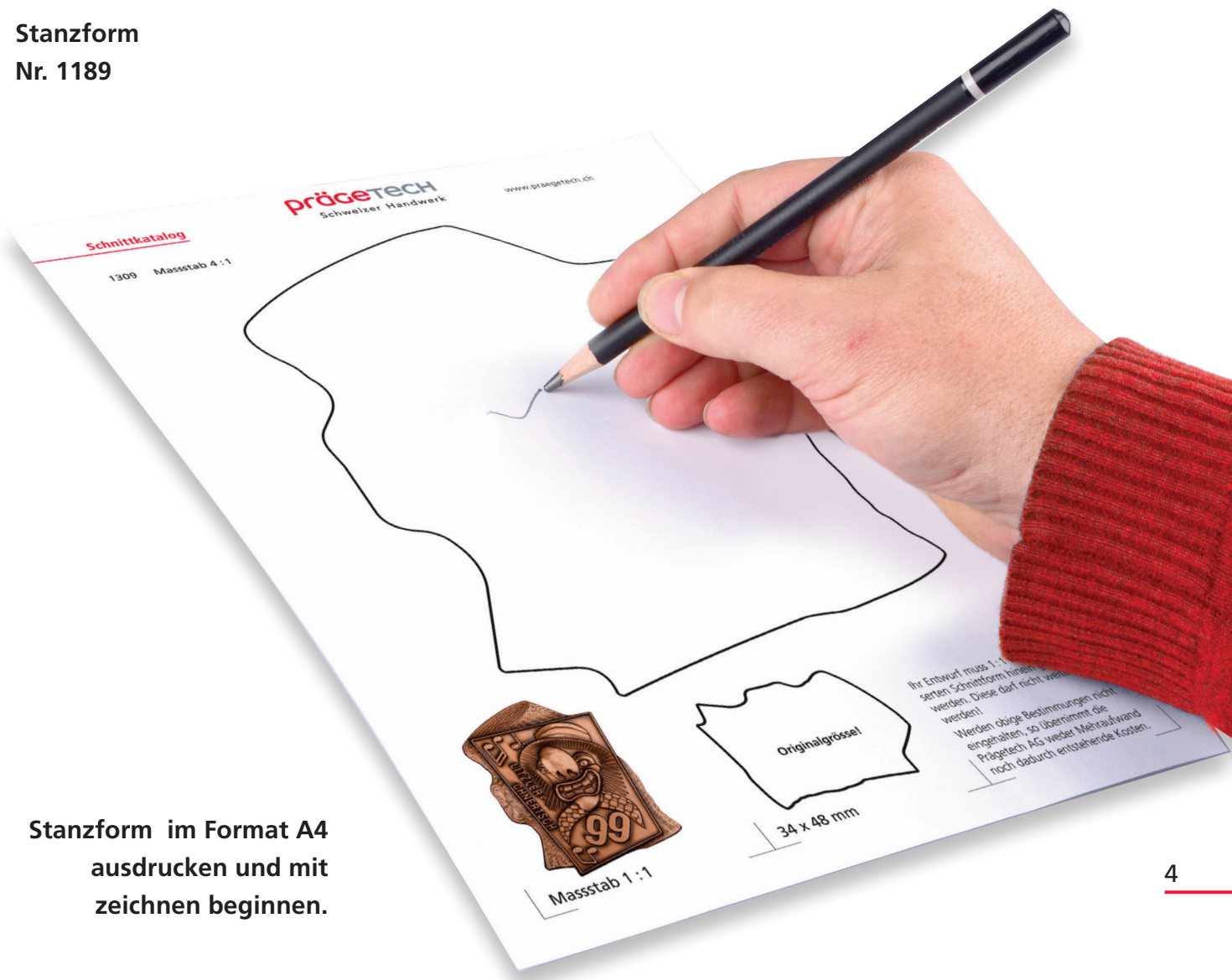

Stanzform im Format A4 ausdrucken und mit zeichnen beginnen.

Besuchen Sie uns jetzt!
www.praegetech.ch/schnittkatalog

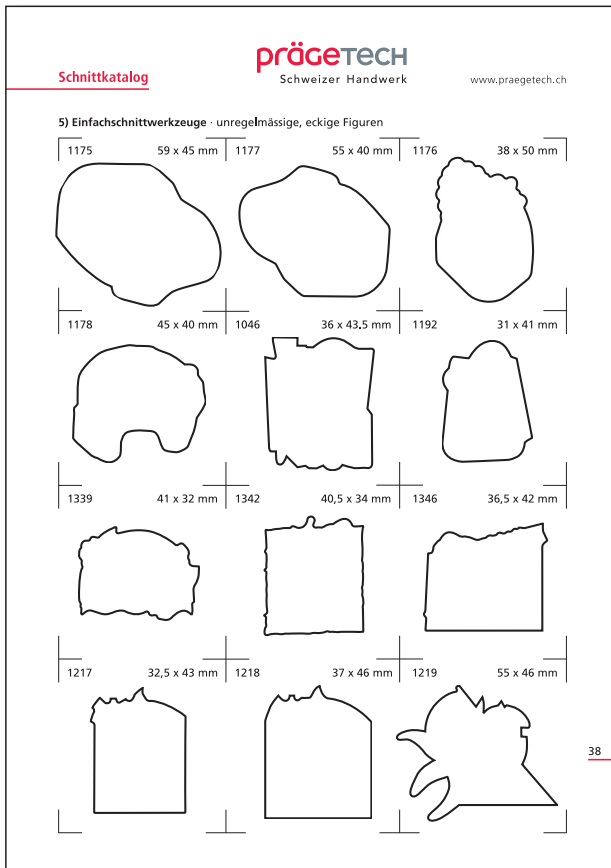

Eine Übersicht der Schnittformen im Format 1 : 1

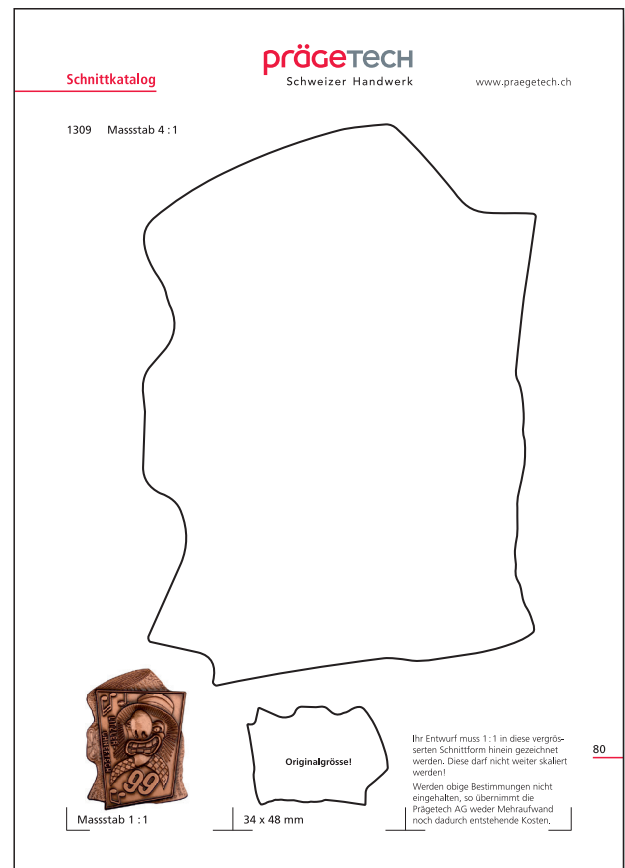

Einfachschnitt im Format 4:1

Plaketten ganz einfach entwerfen

Nachfolgend finden Sie unterschiedliche Schnittformen für Ihre Wunschplakette. Starten Sie noch heute Ihren Designprozess. Auf unserer Website finden Sie alle Schnitte 4-fach vergrössert auf A4 und in Originalgrösse.

Zeichnen Sie Ihre Idee nun bequem in die im Masstab 4 : 1 dargestellte Schnittform.

Die vergrösserten Schnittformen auf A4 können entweder für das Gestalten auf Papier ausgedruckt oder am Computer für die digitale Gestaltung weiterverarbeitet werden.

Sollte Ihre Schnittform nicht vorhanden sein oder wünschen Sie eine individuelle Schnittform, beraten wir Sie gerne bei einem persönlichen Gespräch.

1309 Masstab 4 : 1

Musterzeichnung



Masstab 1 : 1

34 x 48 mm

Originalgrösse!

Ihr Entwurf kann hier 1:1 in diese vergrösserte Schnittform hinein gezeichnet werden.

1348 Masstab 4 : 1

Musterzeichnung



Masstab 1 : 1

40.5 x 30,7 mm



Originalgrösse!

Ihr Entwurf kann hier 1 : 1 in diese vergrösserte Schnittform hinein gezeichnet werden.

1003 Masstab 4 : 1

Musterzeichnung



Masstab 1 : 1

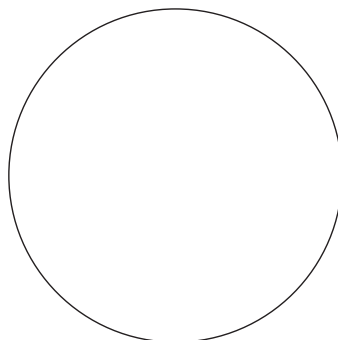

Ø 42 mm

Ihr Entwurf kann hier 1 : 1 in diese vergrößerte Schnittform hinein gezeichnet werden.

1385 Masstab 4 : 1

Musterzeichnung



Masstab 1 : 1

34 x 48 mm



Originalgrösse!

Ihr Entwurf kann hier 1 : 1 in diese vergrößerte Schnittform hinein gezeichnet werden.

Zeichnen Sie in Ihrem eigenen Stil.

Ob Bleistiftskizze, Filzstift oder Gouache – unsere Graveure interpretieren fachmännisch Ihre Idee und schaffen daraus Ihr individuelles Meisterwerk.

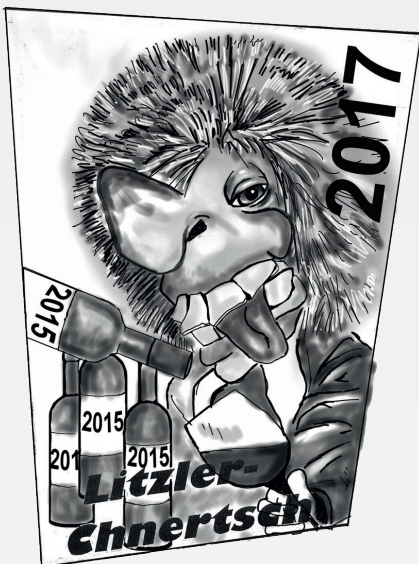

Entdecken Sie die Vielfalt unserer Befestigungen!

Ob Nadel, Pinstift, Kordel oder Kette -
Wir sind allen Anforderungen gewachsen!



Plaketten



Entdecken Sie die Vielfalt unserer Grundplatten!

Ob Grösse, Form, Material und Befestigung – Bei uns finden Sie für jeden Geschmack passende und individuelle Lösungen.

Kupfer



Kupfer strukturiert



Glanzvernickelt



Messing



Messing strukturiert



Neusilber



Vergoldet



Vergoldet strukturiert



Aluminium farbig eloxiert





Plaketten

Übersicht Einzelschnitte:

- 1) Ellipsen, Kreise und abgeleitete Figuren

1) Ellipsen · Kreise und abgeleitete Figuren

1203	Ø 10 mm	1149	Ø 19 mm	1039	Ø 21 mm
------	---------	------	---------	------	---------

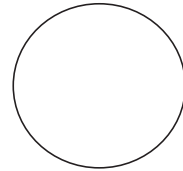
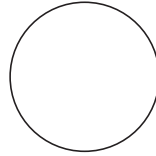

1150	Ø 23 mm	1374	Ø 25 mm	1139	Ø 27 mm
------	---------	------	---------	------	---------

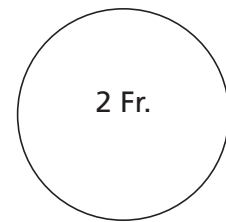
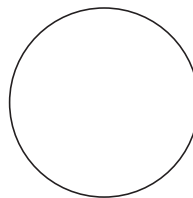
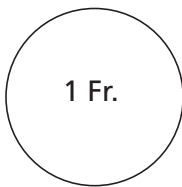

1403	Ø 29 mm	1151	Ø 31 mm	1034	Ø 32,4 mm
------	---------	------	---------	------	-----------

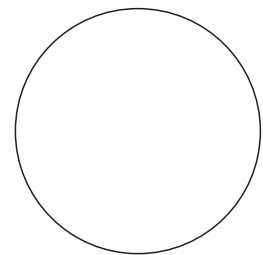
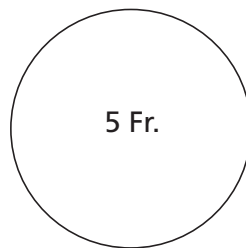
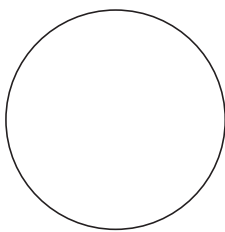

1030	Ø 35 mm	1071	Ø 36.8 mm	1345	Ø 39 mm
------	---------	------	-----------	------	---------

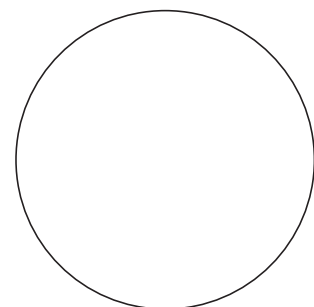
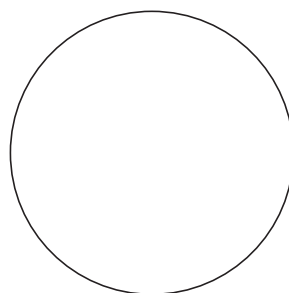
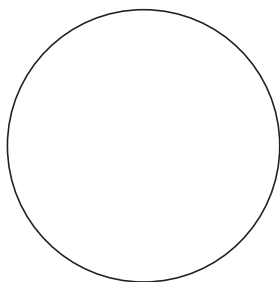

1) Ellipsen · Kreise und abgeleitete Figuren

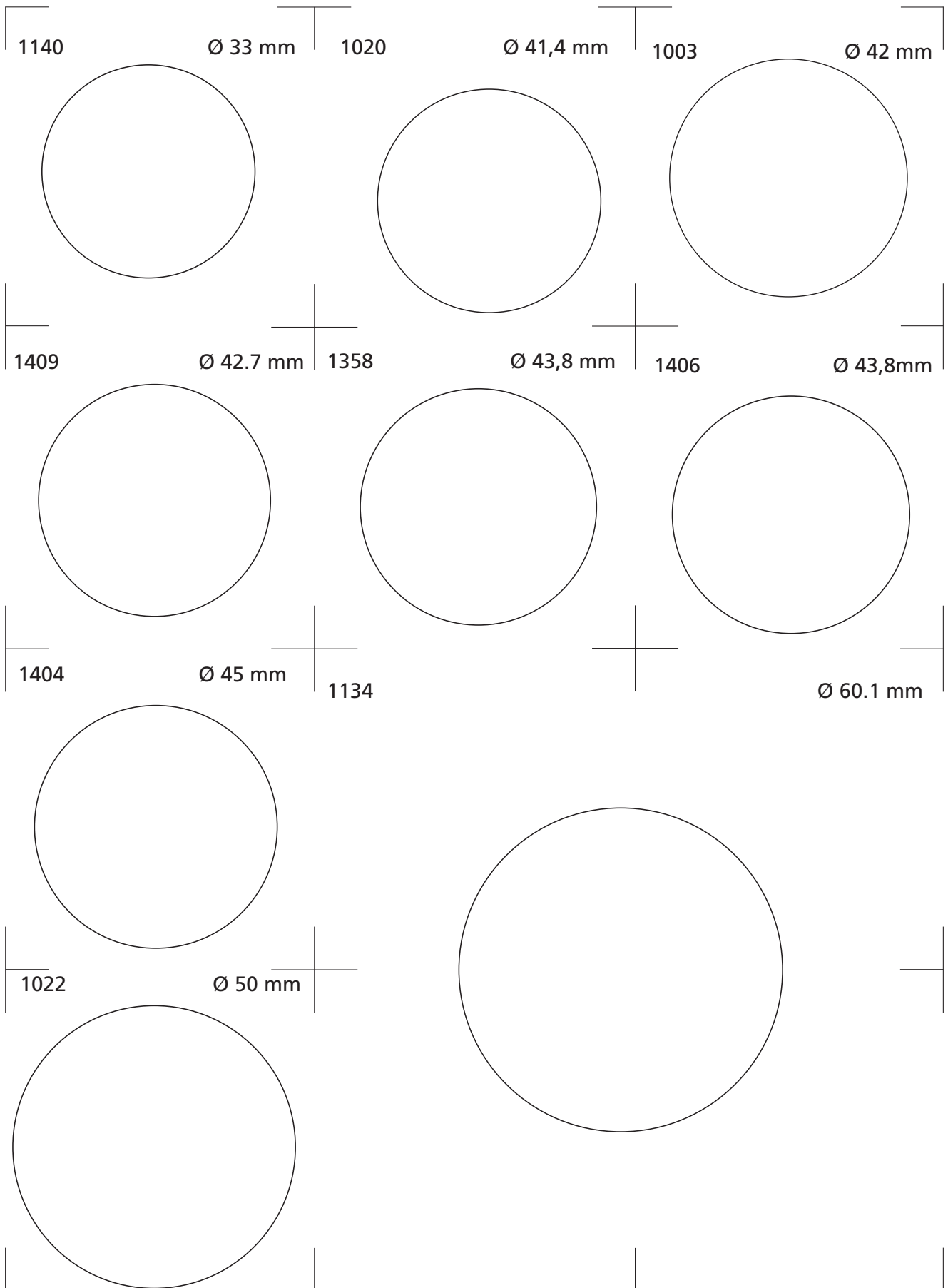

1) Ellipsen · Kreise und abgeleitete Figuren

1005 15 x 10 mm 1021 20 x 12 mm 1040 45,8 x 38 mm

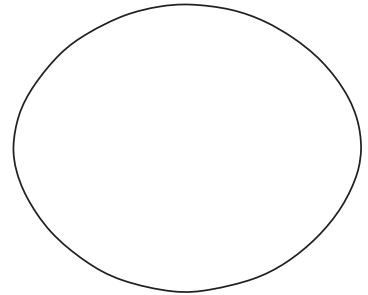
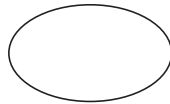
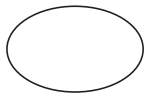

1052 58,9 x 37,3 mm 1076 59,9 x 42 mm

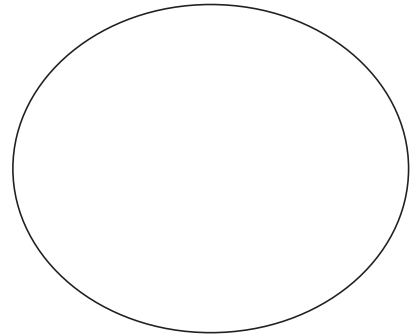
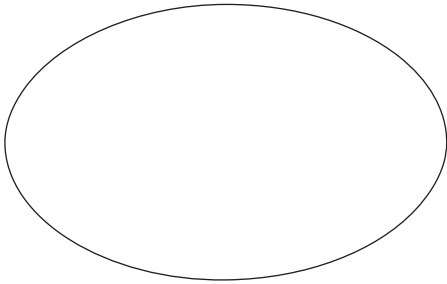

1060 48,3 x 37,6 mm 1161 59,9 x 26 mm

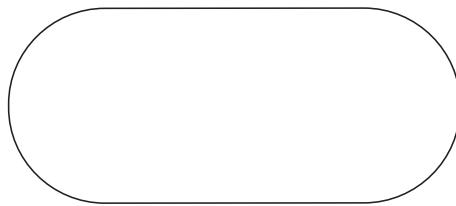
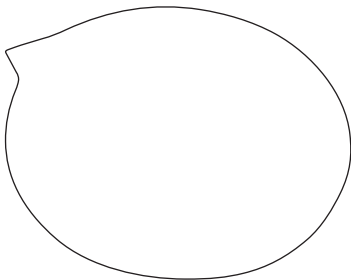

1112 20 x 12,9 mm

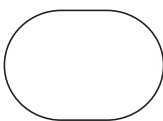

1) Ellipsen · Kreise und abgeleitete Figuren

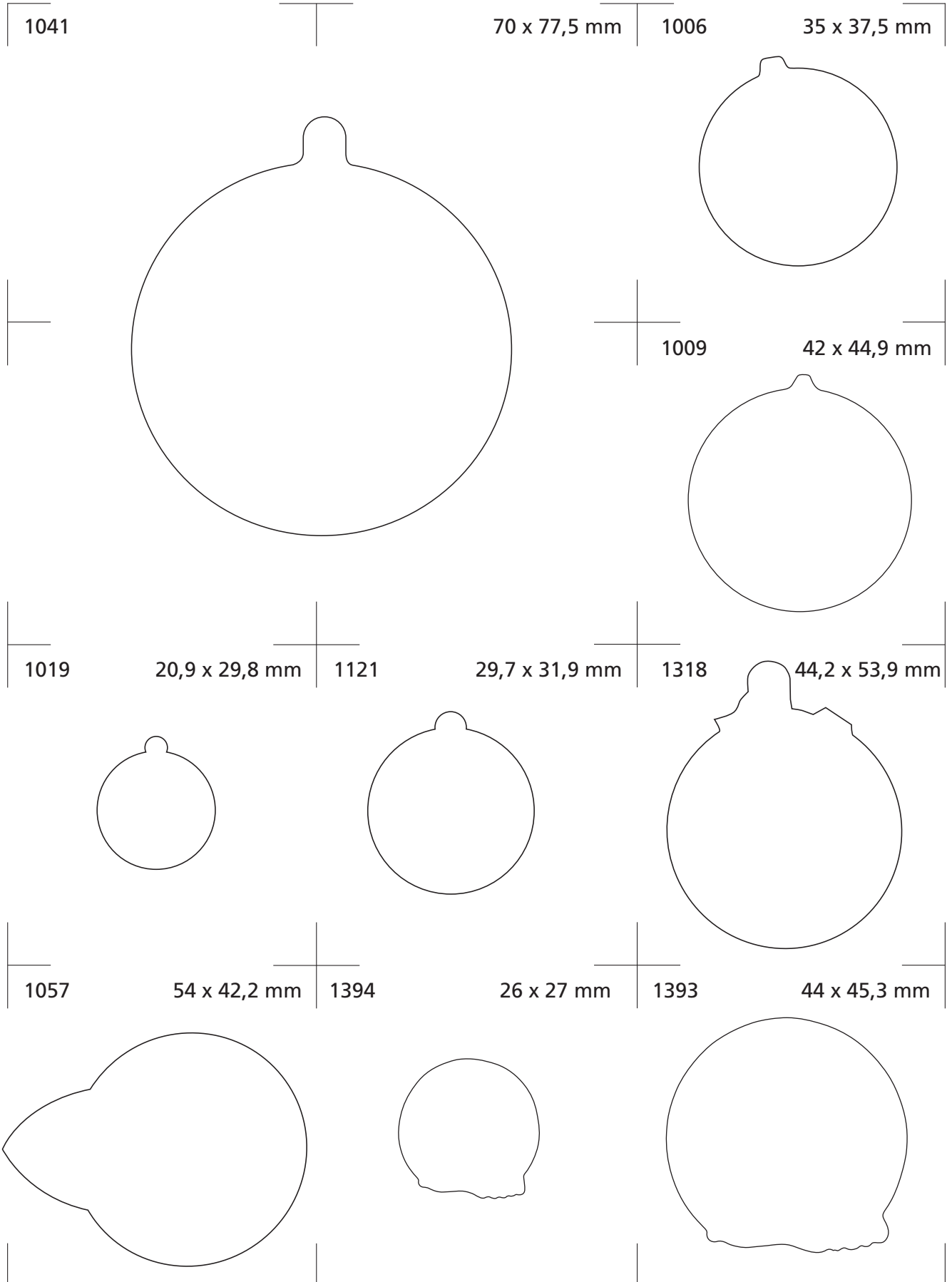

1) Ellipsen · Kreise und abgeleitete Figuren

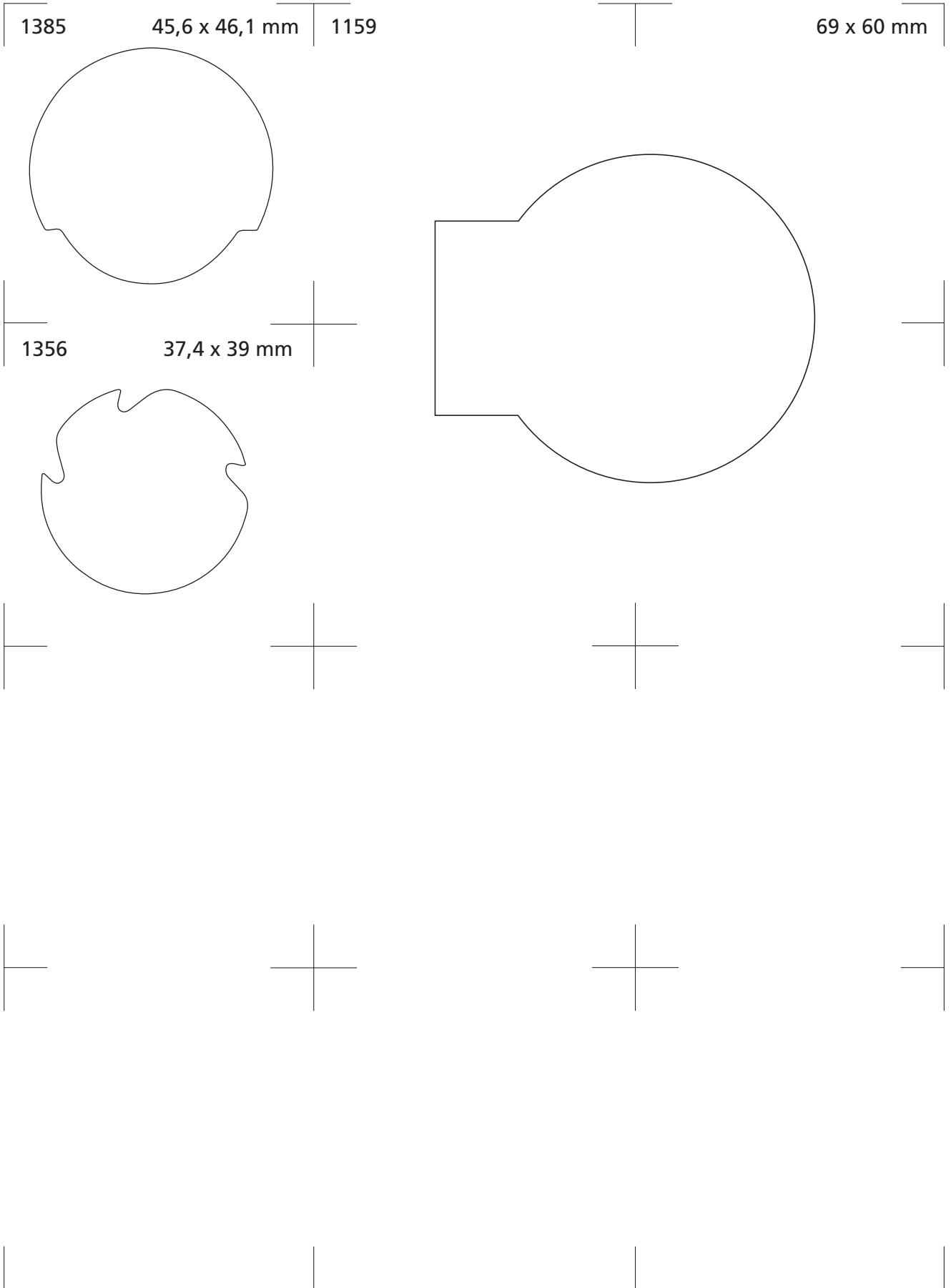



Plaketten

Einfachschnitte:

2) Vierecke · Rechtecke · Quadrate

2) Vierecke · Vom Rechteck abgeleitete Figuren

1198 19 x 15 mm 1372 30 x 24 mm 1004 30 x 25 mm



1016 36 x 28,8 mm 1044 42,1 x 32,1 mm 1056 40,1 x 31 mm

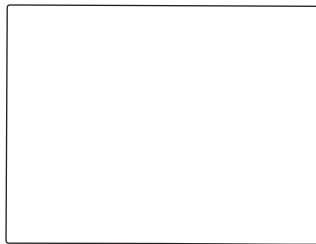

1001 50 x 32 mm 1228 83 x 50 mm



1411 44 x 44 mm

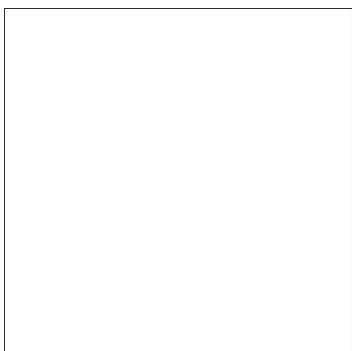

2) Vierecke · Vom Rechteck abgeleitete Figuren

1100	53,9 x 16,4 mm	1101	49 x 16,3 mm	1131	40 x 12 mm
------	----------------	------	--------------	------	------------

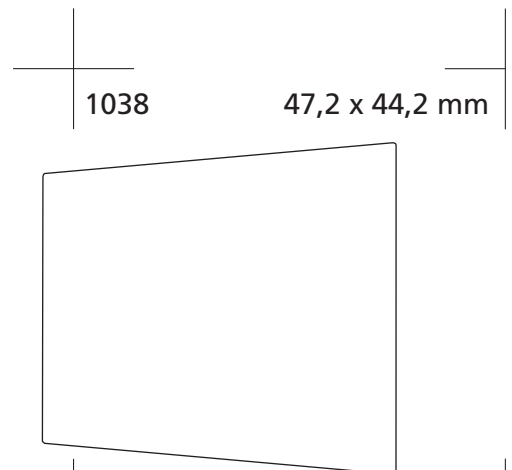
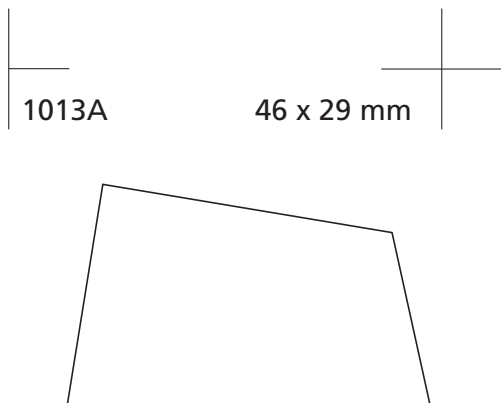
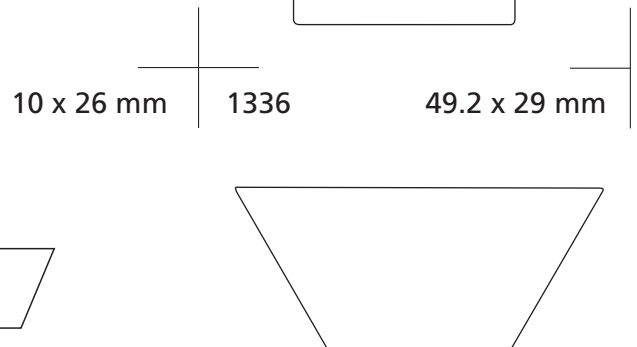
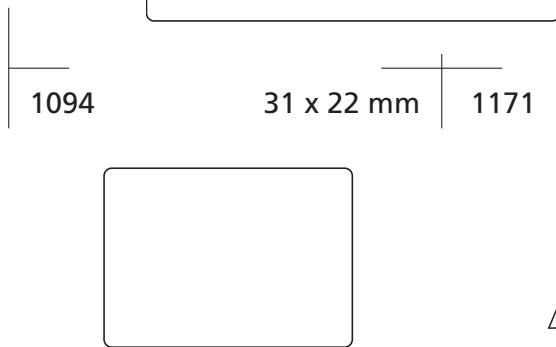
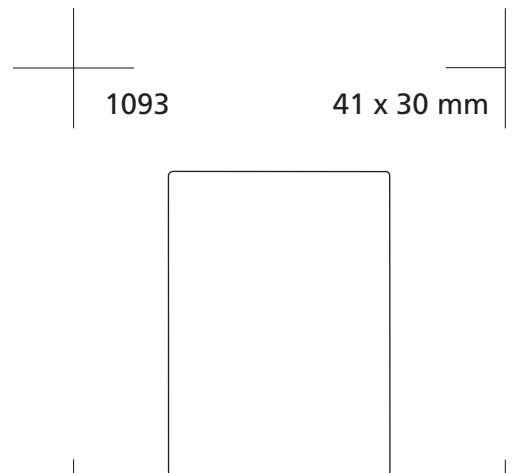
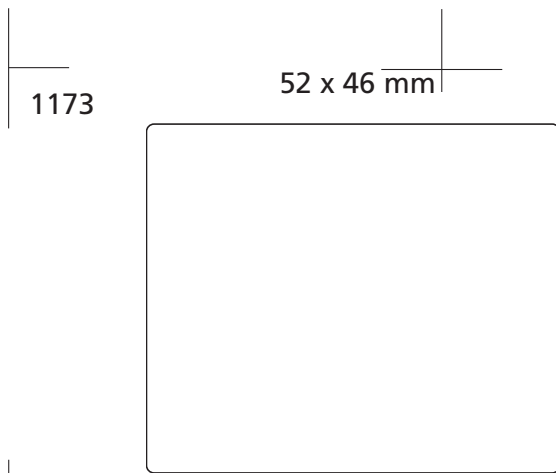

2) Vierecke · Vom Rechteck abgeleitete Figuren

1321 36 x 36 mm 1084 36,6 x 34,7 mm 1025 40 x 40 mm

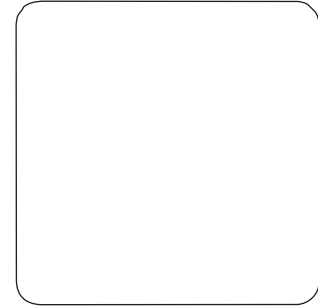
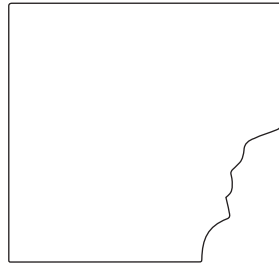
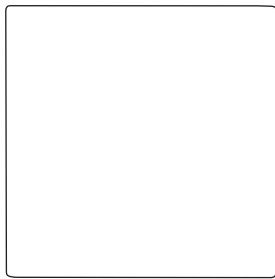



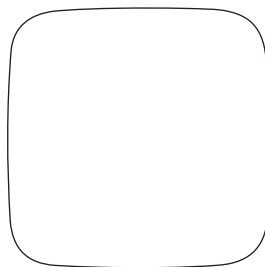
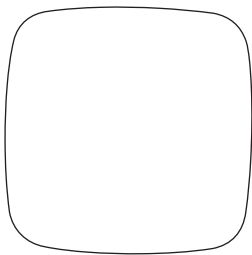

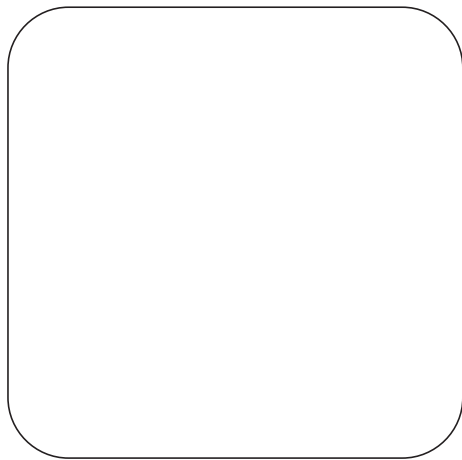

1014A 33 x 33 mm 1017 35 x 35 mm

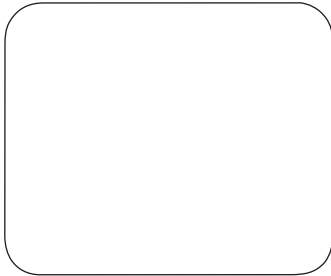

1185B 60 x 60 mm

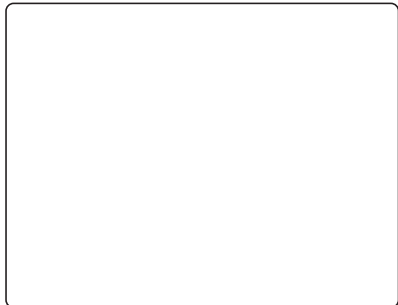

2) Vierecke · Vom Rechteck abgeleitete Figuren

1032	50 x 38 mm	1135	43,8 x 36,5 mm	1199	45 x 25 mm
					
1106		68 x 28 mm	1141	18 x 8 mm	
					
1047	60 x 20 mm		1172	46 x 26 mm	
					
1197		62,6 x 19,6 mm	1174	50 x 40 mm	
					

2) Vierecke · Vom Rechteck abgeleitete Figuren

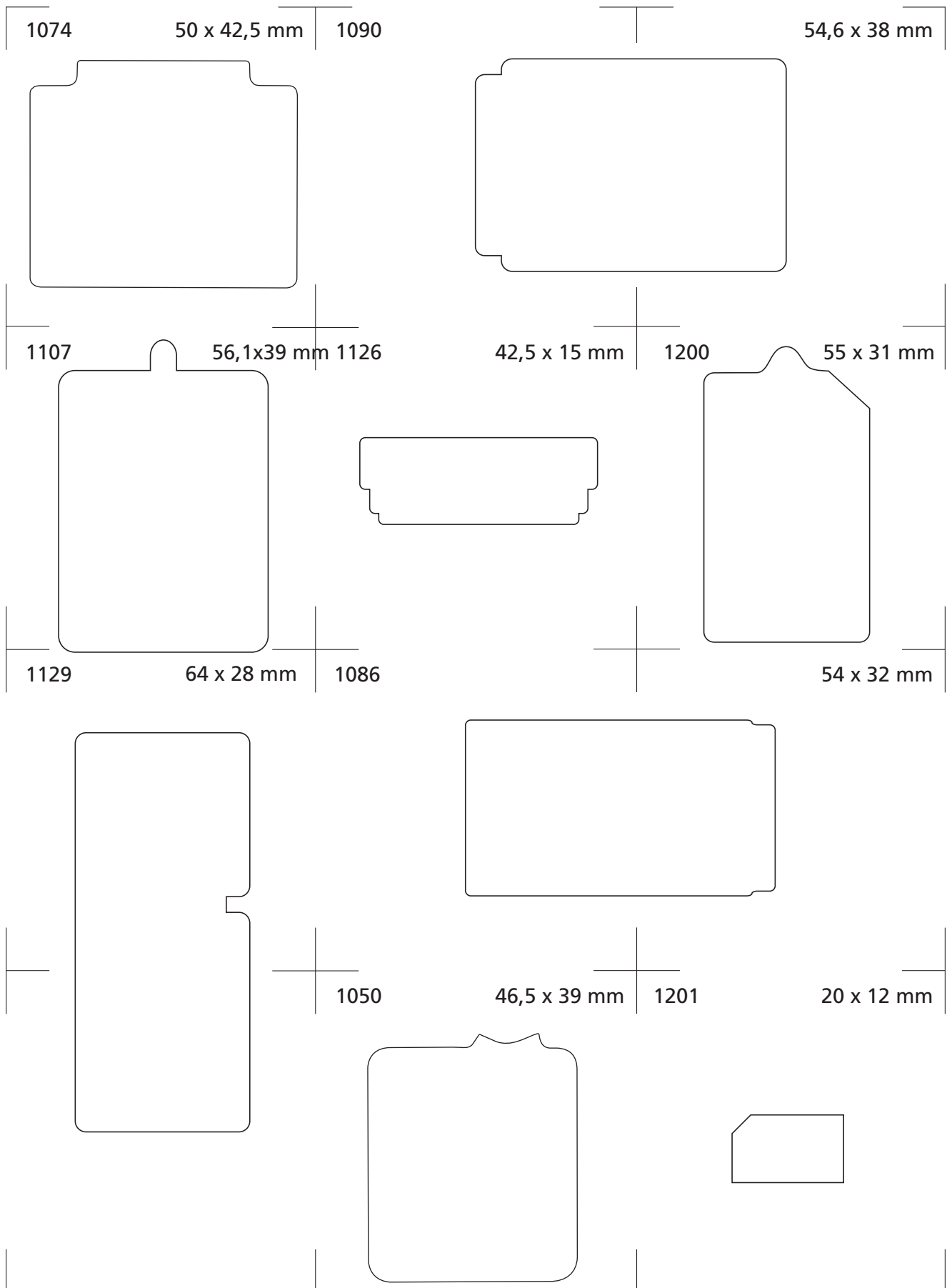

2) Vierecke · Vom Rechteck abgeleitete Figuren

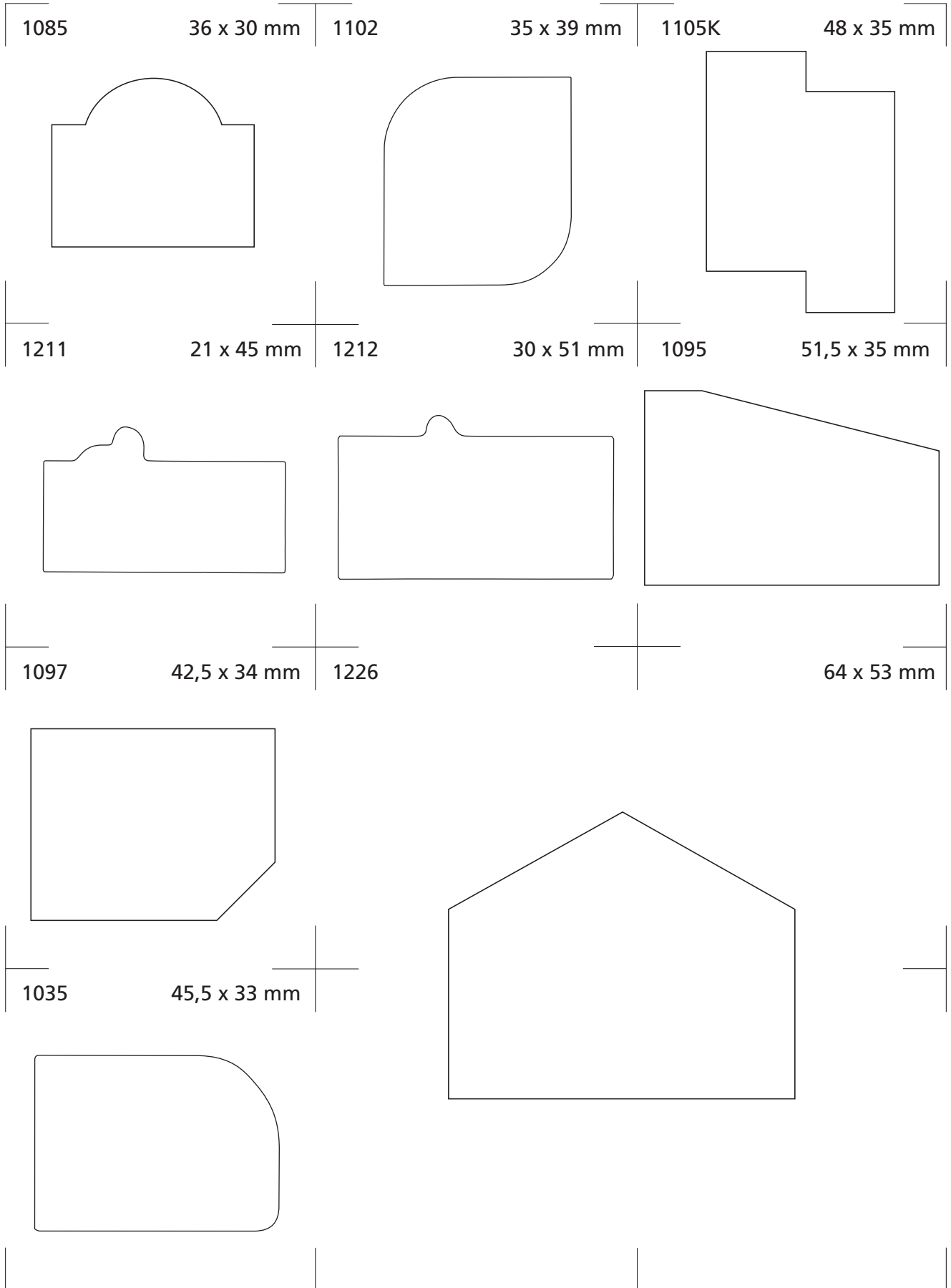



Plaketten

Einfachschnitte:

3) Dreiecke · Polygone (Vielecke)

3) Dreiecke und ähnliche

1395 60 x 46 mm

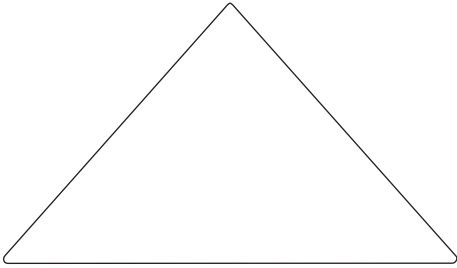

1132 29,6 x 33,4 mm

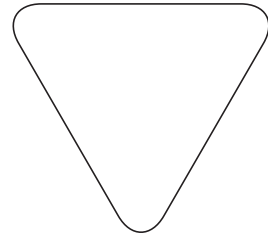

1227 95,6 x 68,2 x 56,8 mm

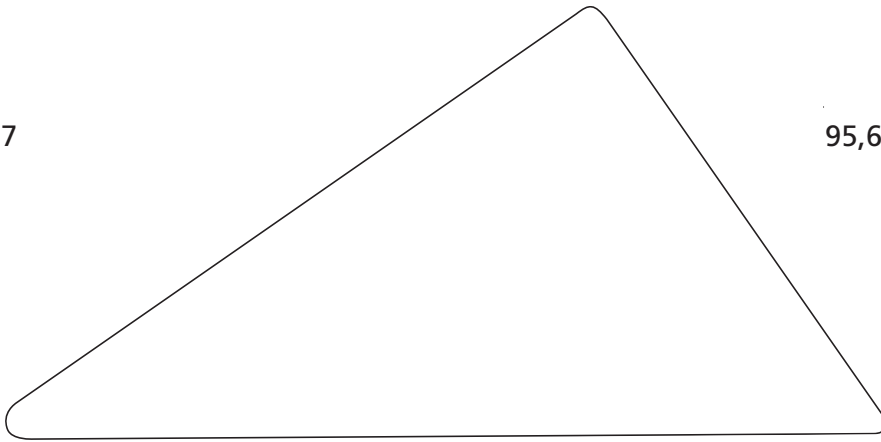

1225 S = 84 x 58 x 48,3 mm

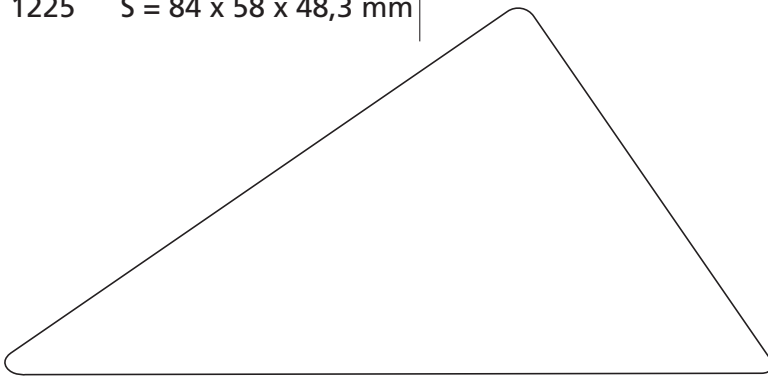

1209 35,7 x 35,9 mm

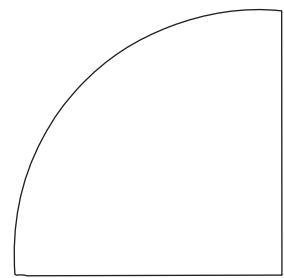

1144 S = 66,7 x 46 x 38 mm 1210 42 x 42 mm

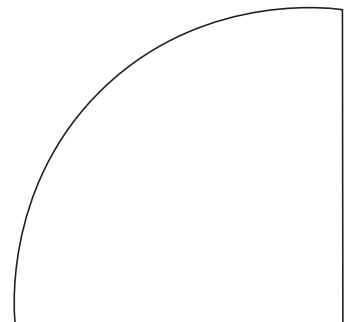
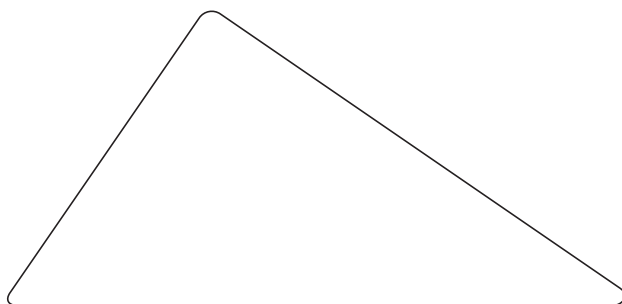

3) Polygone (Vielecke)

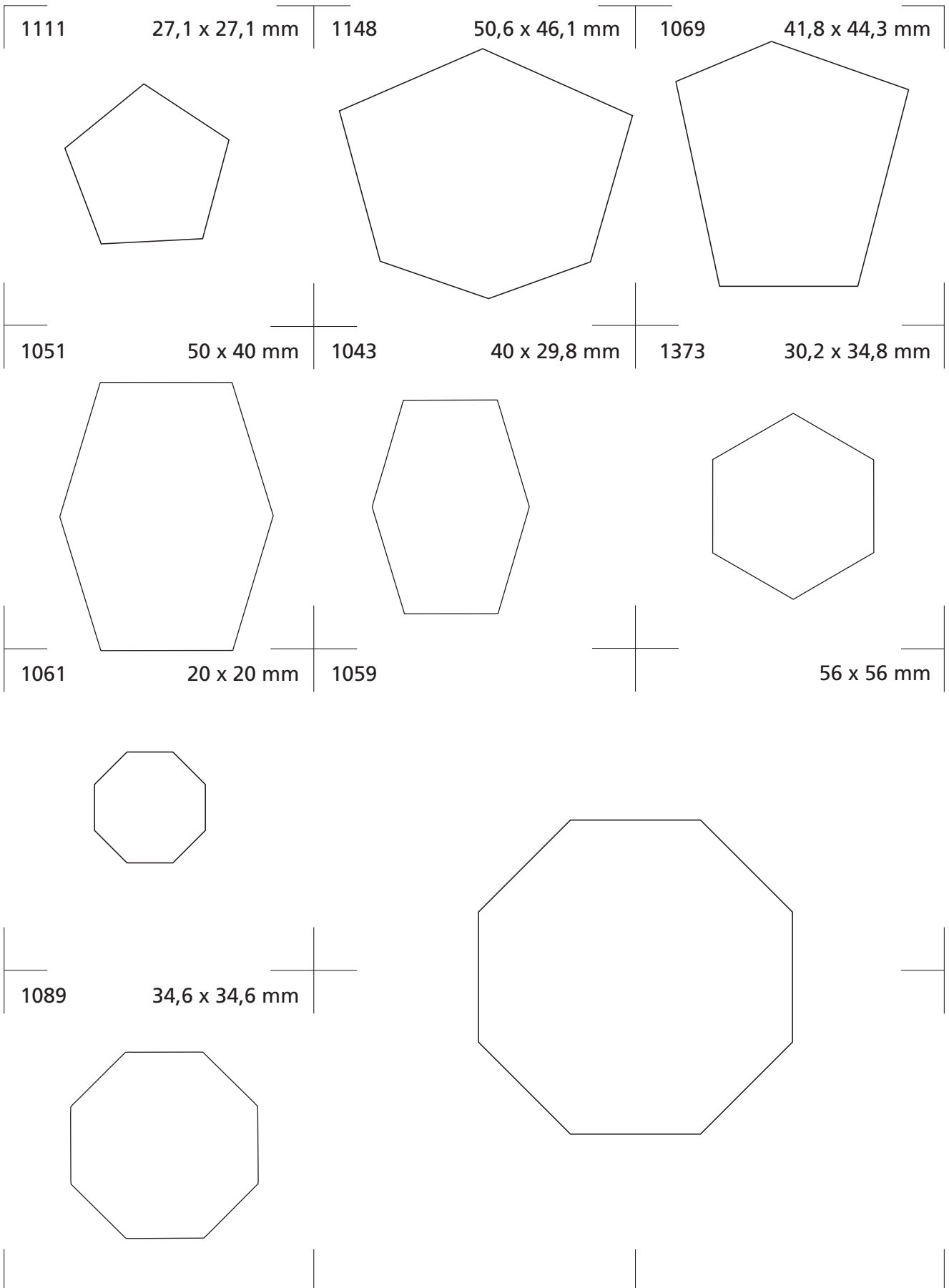

3) Polygone (Vielecke)

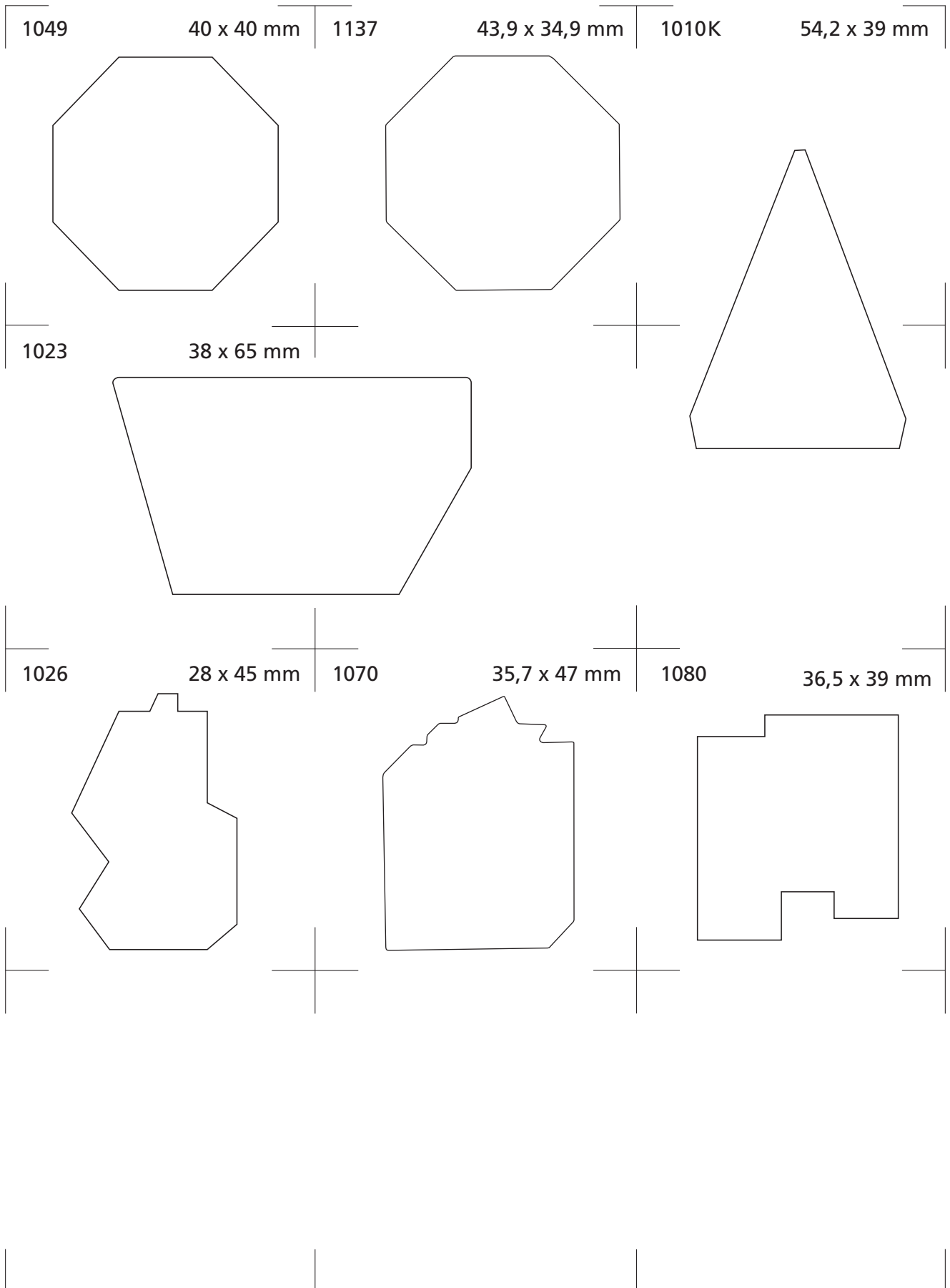



Plaketten

Einfachschnitte:

4) unregelmässige, gerundete Figuren

4) Unregelmässige, gerundete Figuren

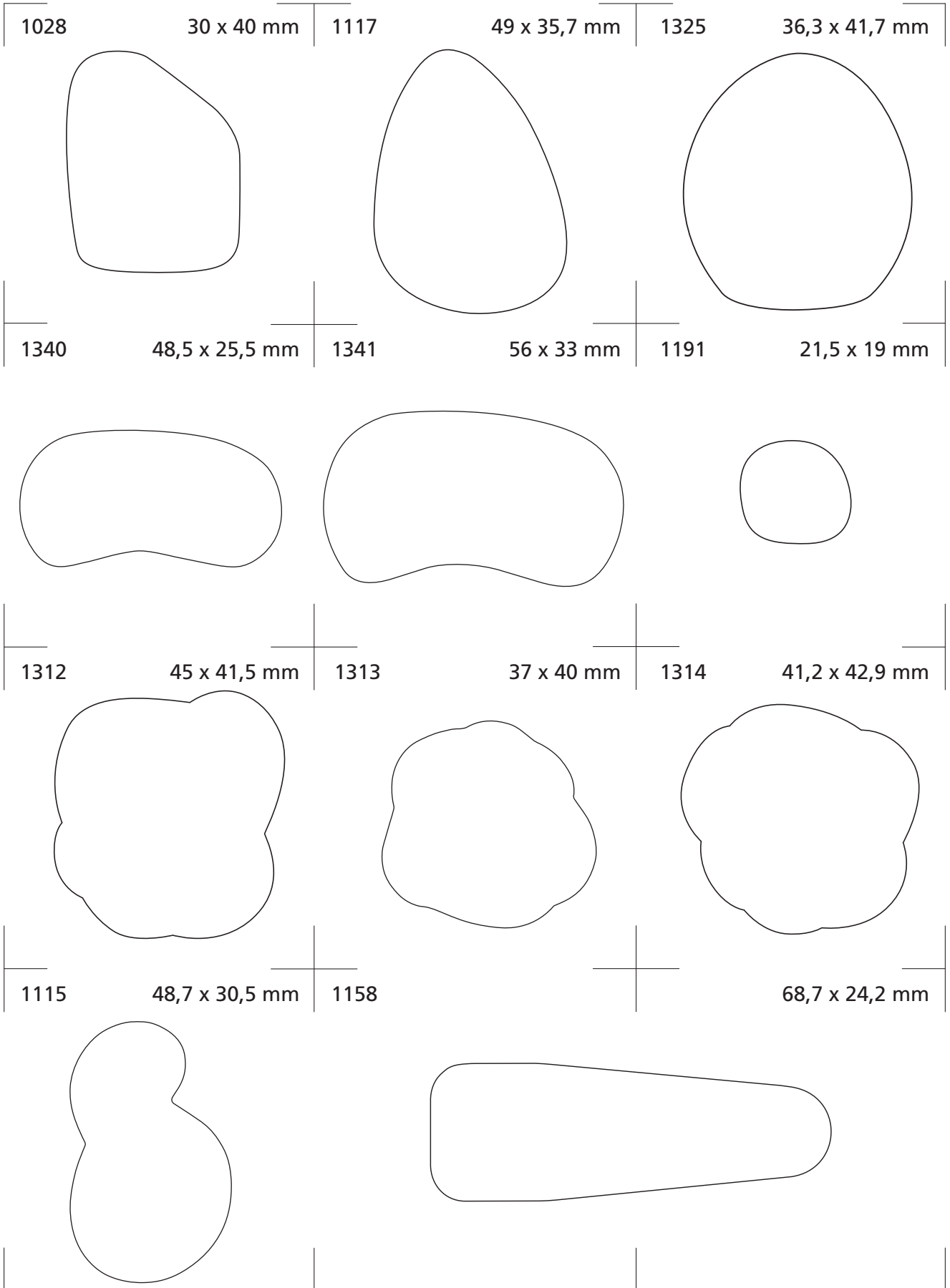

4) Unregelmässige, gerundete Figuren

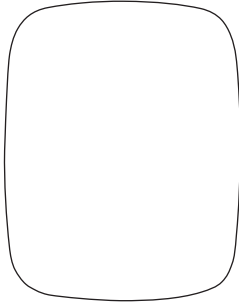
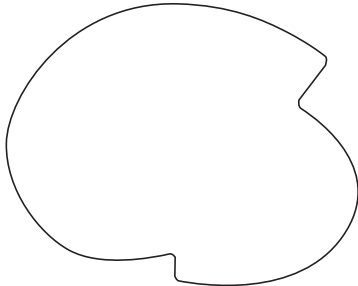
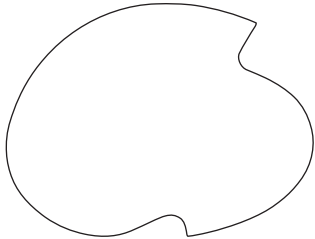
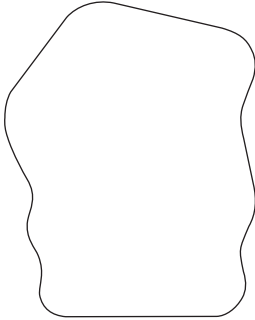
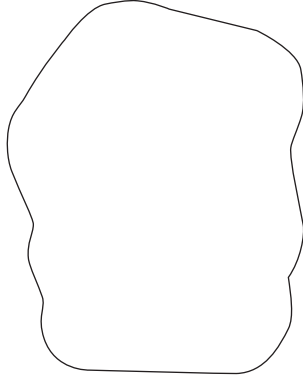
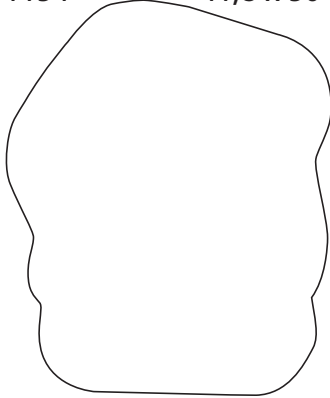
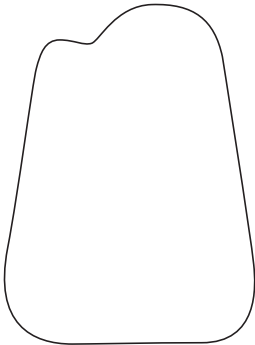
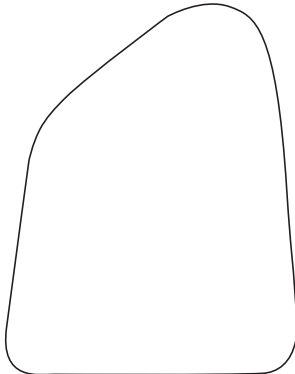
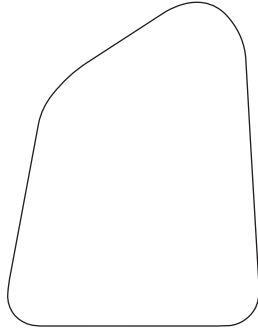
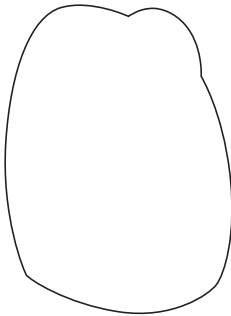
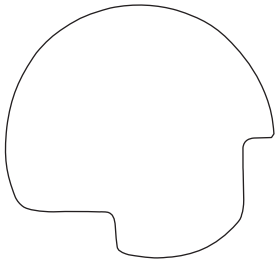
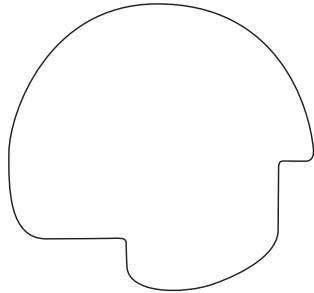
1013B	38 x 45 mm	1347	46 x 36 mm	1348	41,1 x 31,5 mm
					
1152	34,7 x 42,2 mm	1153	38,6 x 46,9 mm	1154	41,8 x 50 mm
					
1193	33,7 x 45,4 mm	1185	38,9 x 50 mm	1186A	33,5 x 43 mm
					
1127	30 x 40,5 mm	1315	36 x 34 mm	1316	40,7 x 33,4 mm
					

4) Unregelmässige, gerundete Figuren

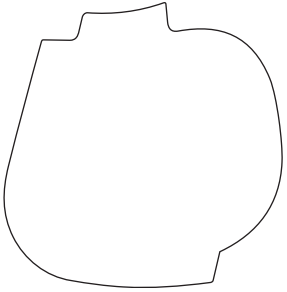
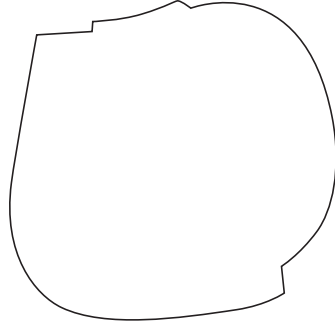
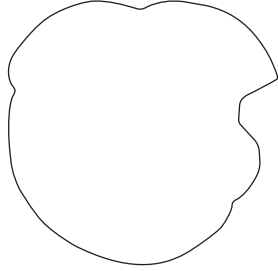
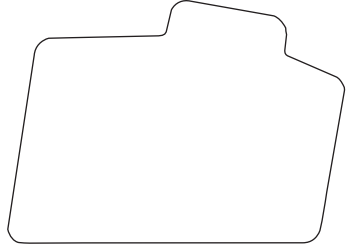
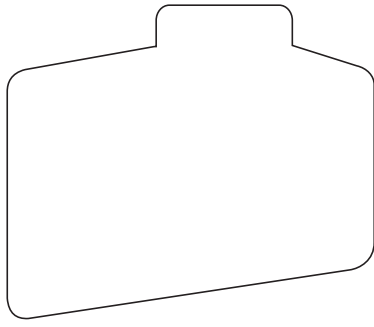
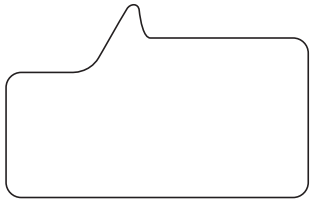
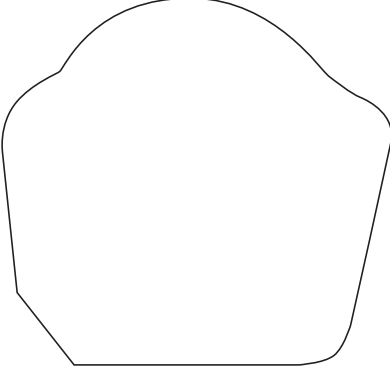
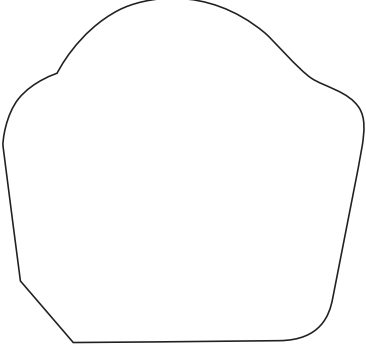
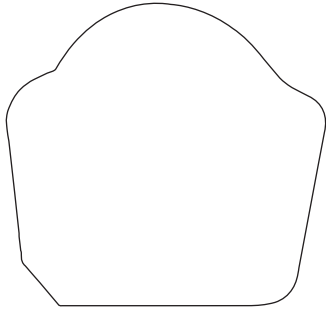
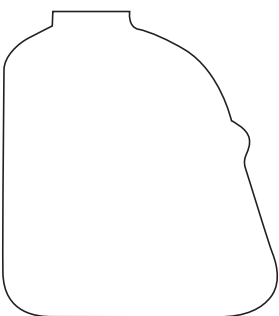
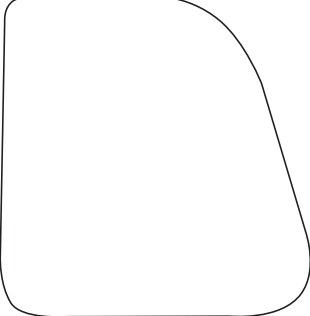
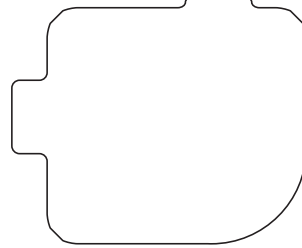
1363	35,8 x 38 mm	1364	41 x 42 mm	1371	37 x 38 mm
					
1113	45 x 32,6 mm	1114	37,8 x 50 mm	1215	40,2 x 26,3 mm
					
1188	51 x 49 mm	1189	46,6 x 48 mm	1190	40,4 x 42,7 mm
					
1205	37,7 x 40,2 mm	1206	41,3 x 42,4 mm	1136	37,7 x 31,9 mm
					

4) Unregelmässige, gerundete Figuren

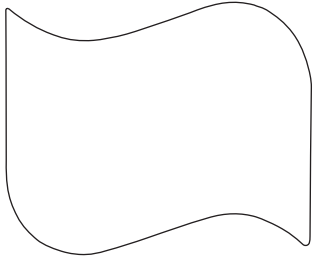
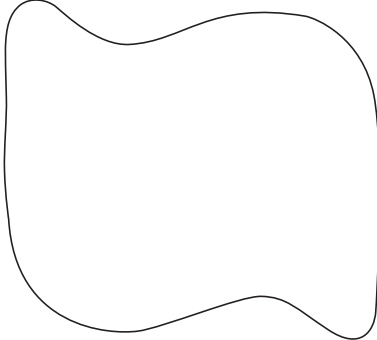
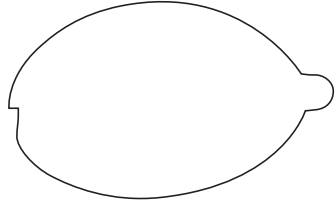
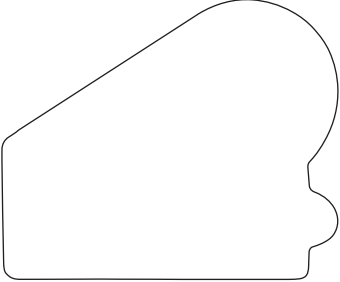
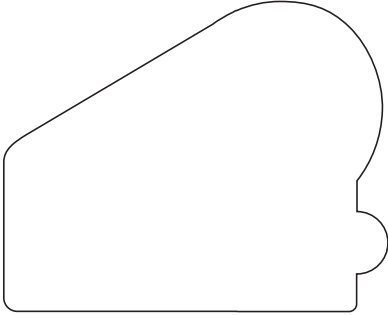
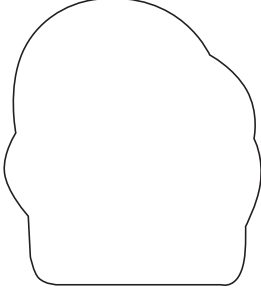
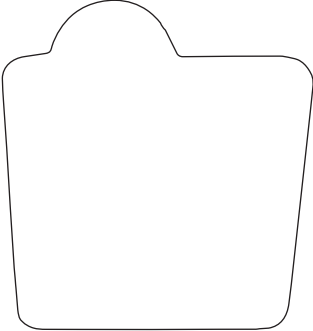
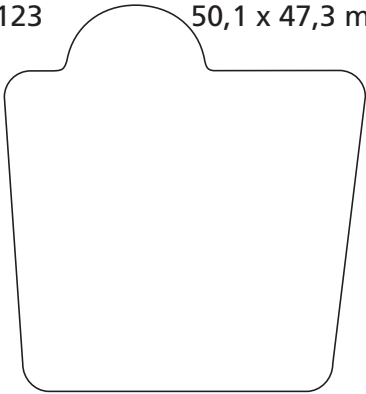
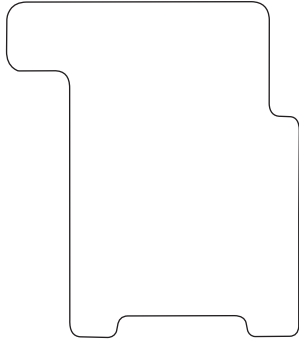
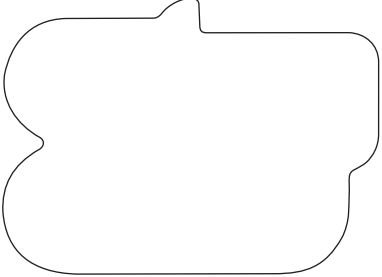
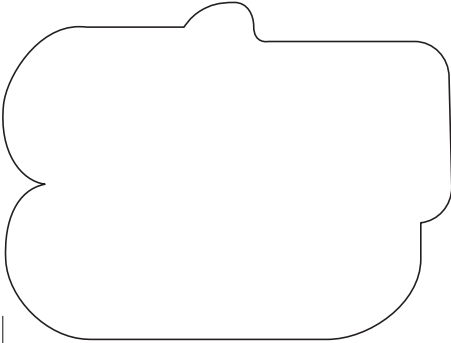
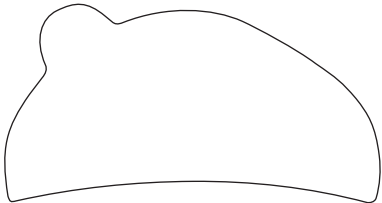
1327	40,5 x 33,5 mm	1328	48 x 43 mm	1317	43,1 x 27 mm
					
1091	52,2 x 37,1 mm	1092	41,1 x 56,8 mm	1167	33,9 x 37,5 mm
					
1122	41,5 x 44 mm	1123	50,1 x 47,3 mm	1027	39 x 44.8 mm
					
1062	40 x 37,6 mm	1063	58,7 x 44,3 mm	1365	50 x 27 mm
					

4) Unregelmässige, gerundete Figuren

1388	33,9 x 25 mm	1387	47,2 x 31 mm	1390	53,9 x 40 mm
1357	44,5 x 40 mm	1362	40 x 48 mm	1014B	38,9 x 35,4 mm
1349	48,5 x 42,9 mm	1350	36 x 43,7 mm	1036	37,7 x 31,9 mm
1367	36,4 x 50 mm	1368	31,7 x 44 mm	1370	36,5 x 34 mm

4) Unregelmässige, gerundete Figuren

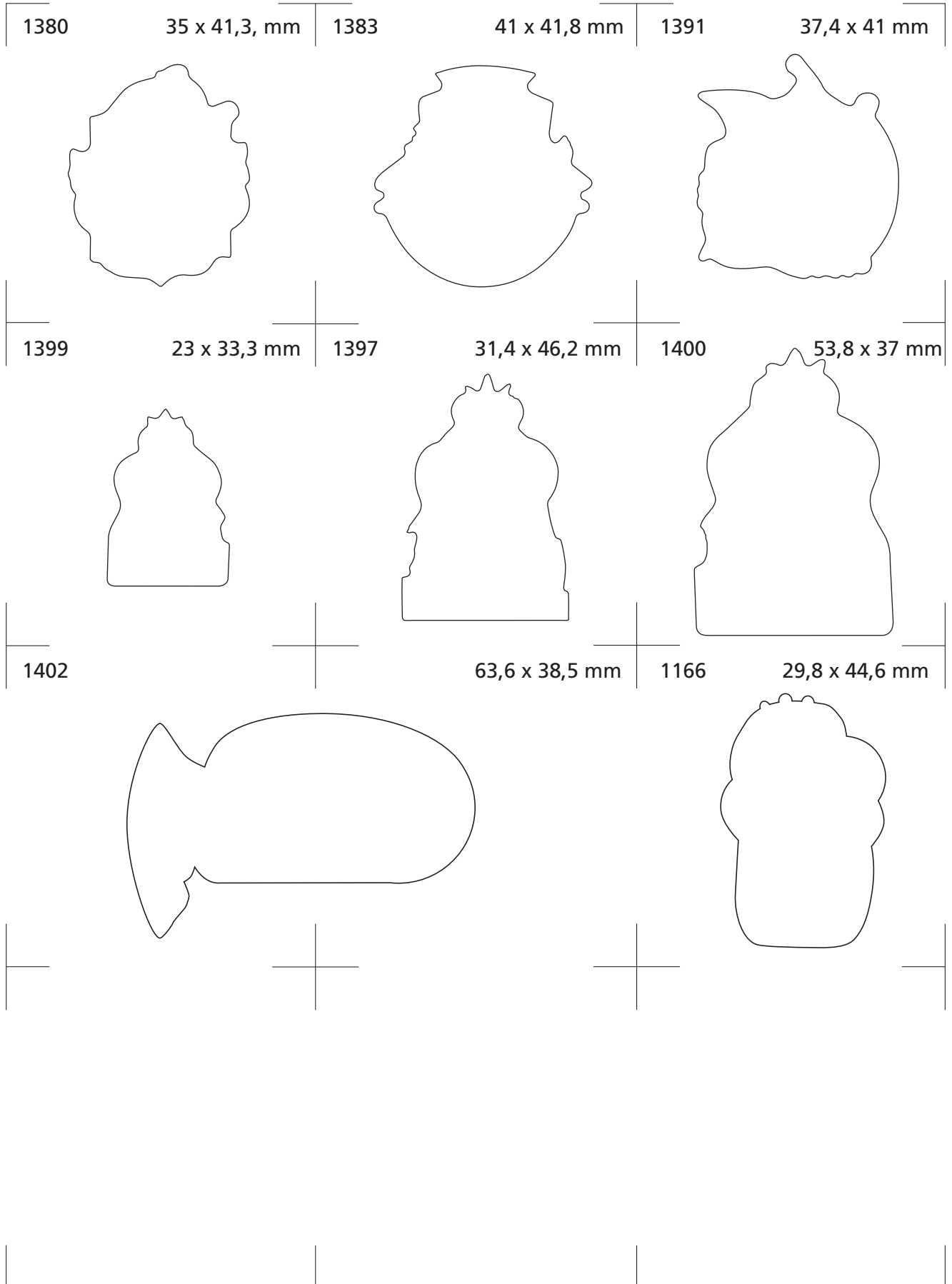



Plaketten

Einfachschnitte:

5) Unregelmässige, eckige Figuren

5) Unregelmässige, eckige Figuren

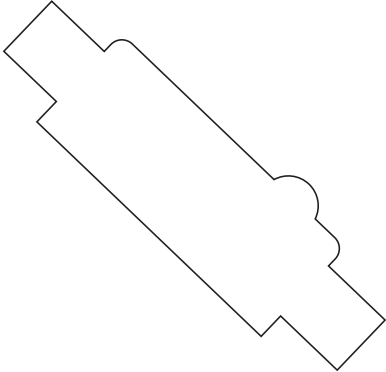
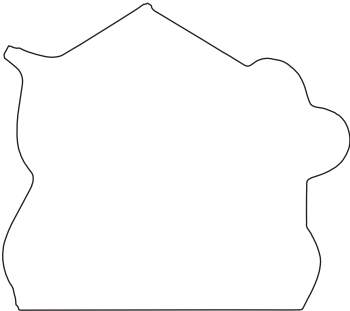
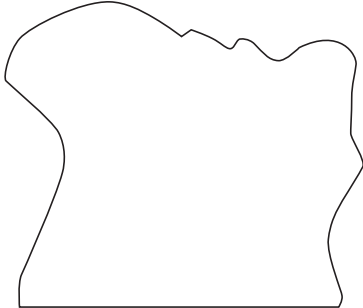
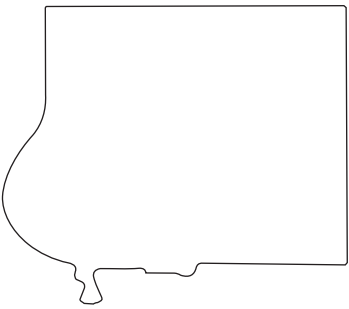
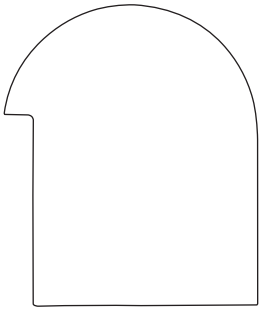
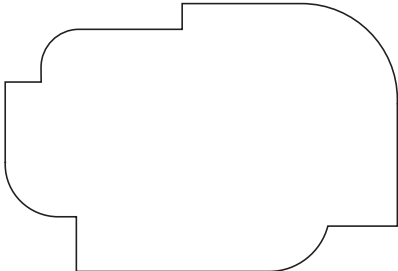
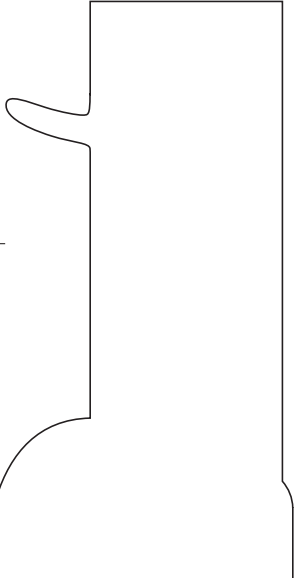
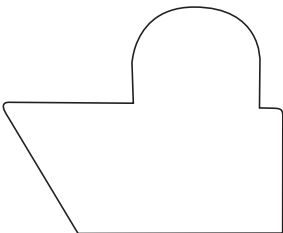
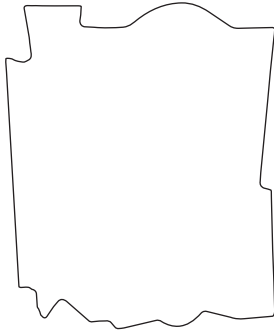
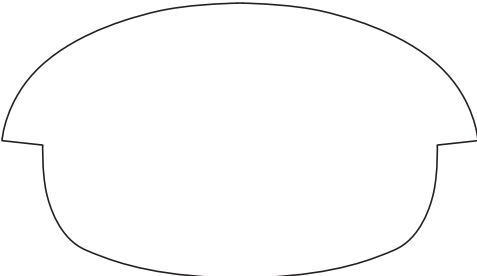
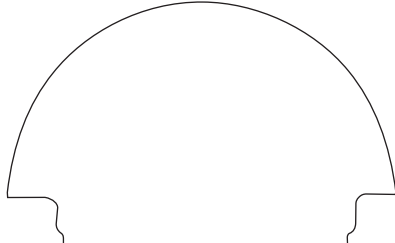
1118	60,9 x 19,4 mm	1103	46 x 40,7 mm	1087	41 x 37,6 mm
					
1053	46,2 x 40 mm	1037	34 x 40 mm	1077	49,7 x 34,5 mm
					
1024	29,8 x 60 mm	1160	35,4 x 29 mm	1046	36,2 x 44,6 mm
					
		1068	59,2 x 35,4 mm	1343	52 x 33 mm
					

5) Unregelmässige, eckige Figuren

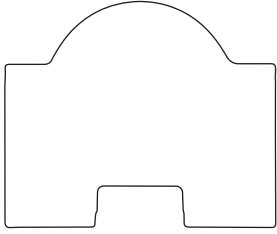
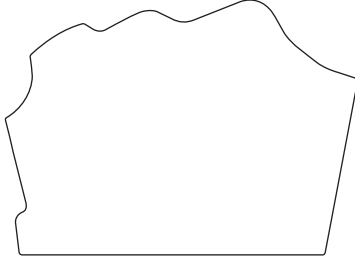
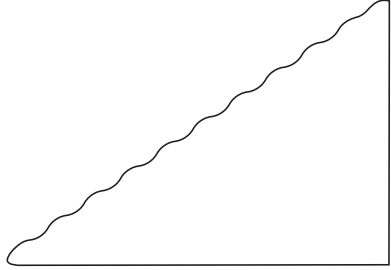
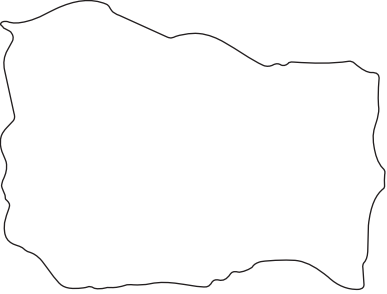
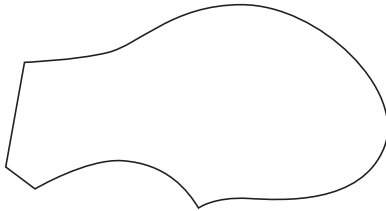
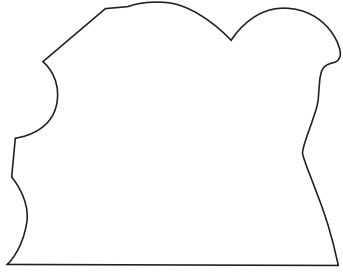
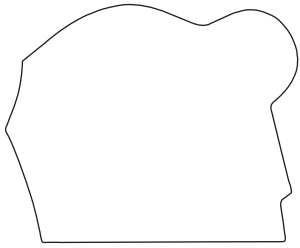
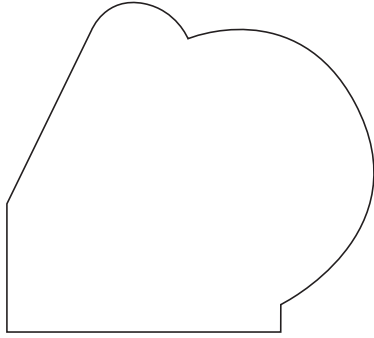
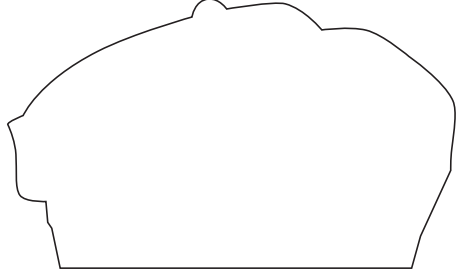
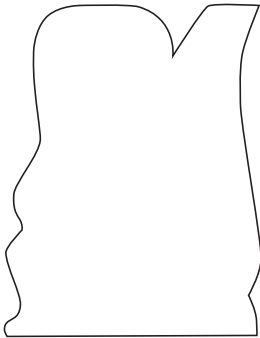
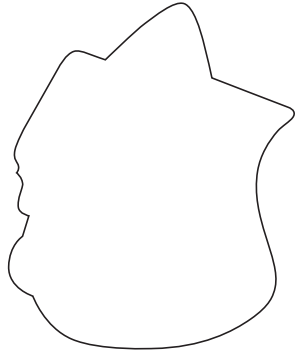
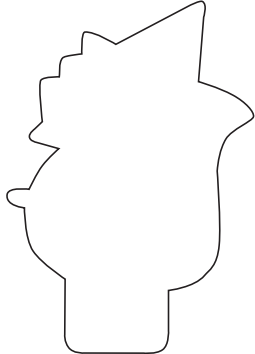
1042	36 x 30 mm	1143	45,4 x 34,2 mm	1145	49,2 x 34,2 mm
					
1058	51 x 37,5 mm	1096	46,2 x 25,9 mm	1124	42,1 x 34,7 mm
					
1133	38,7 x 32,1 mm	1322	48,9 x 44,1 mm	1075	57 x 33,8 mm
					
1155	42,9 x 33,7 mm	1156	39 x 44 mm	1157	30,5 x 45,1 mm
					

5) Unregelmässige, eckige Figuren

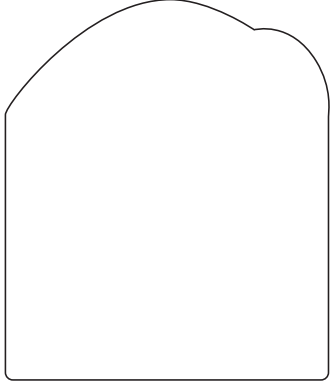
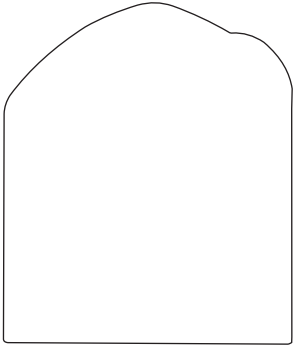
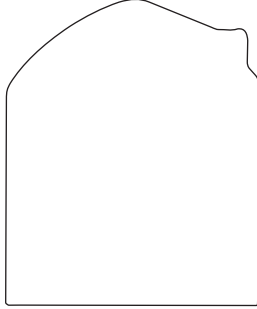
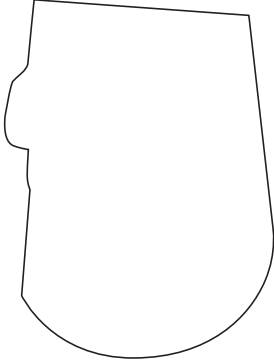
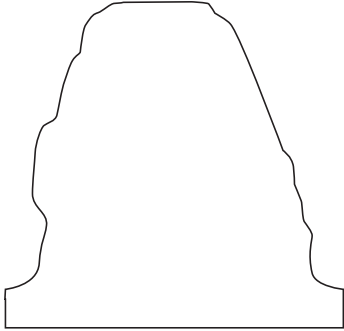
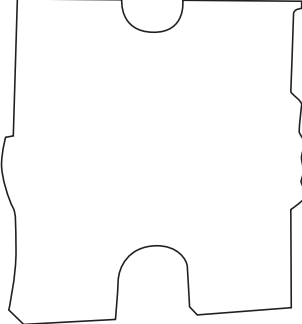
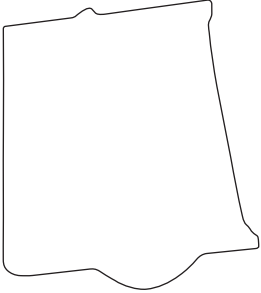
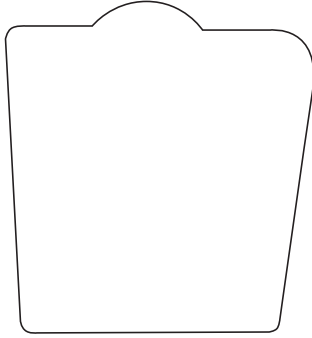
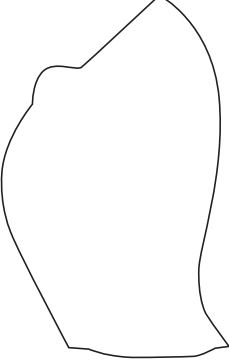
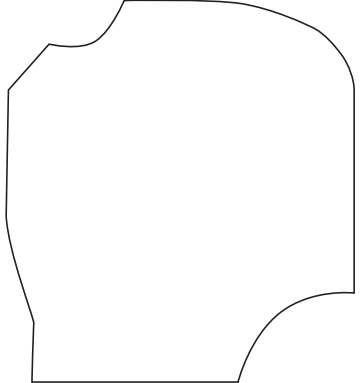
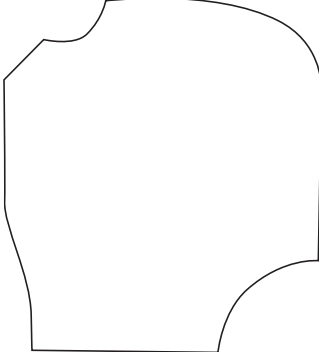
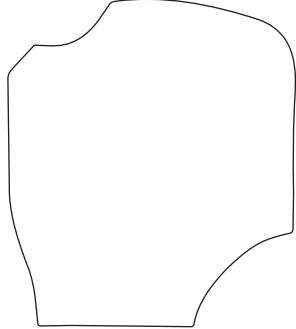
1162	49,7 x 42,3 mm	1163	45,2 x 38,5 mm	1164	40,8 x 33,9 mm
					
1168	34 x 44,8 mm	1170	44,7 x 42,1 mm	1187	43 x 49,9 mm
					
1179	34 x 38,3 mm	1180	44,3 x 41 mm	1181	30 x 48,8 mm
					
1182	51,2 x 46,4 mm	1183	47 x 42,2 mm	1184	37,5 x 43,7 mm
					

5) Unregelmässige, eckige Figuren

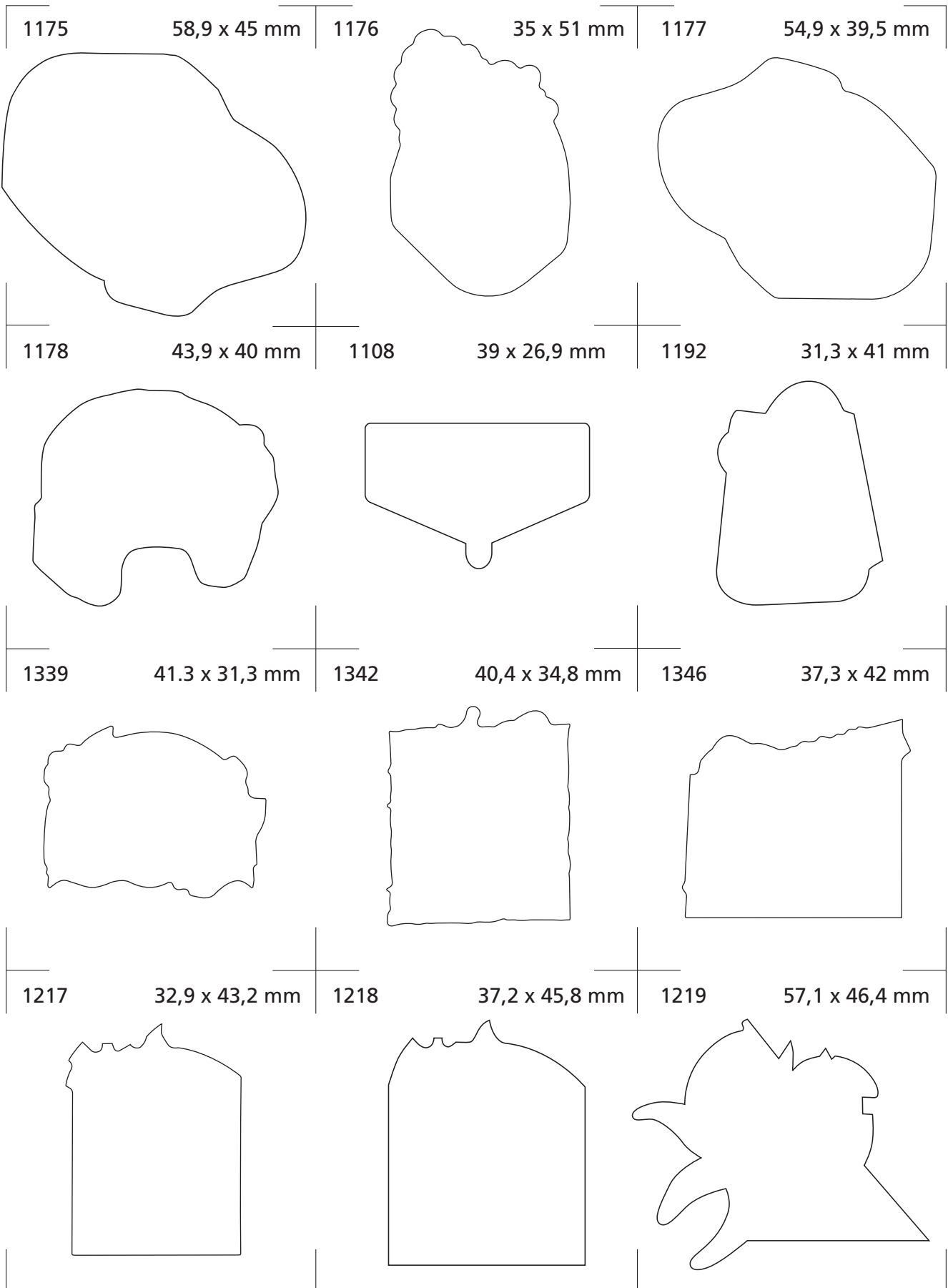

5) Unregelmässige, eckige Figuren

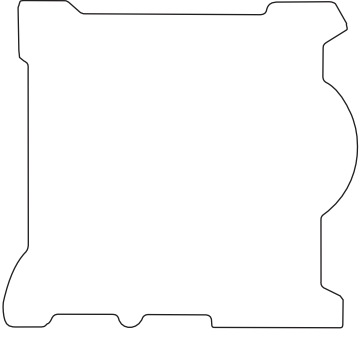
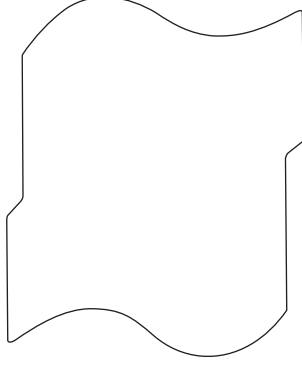
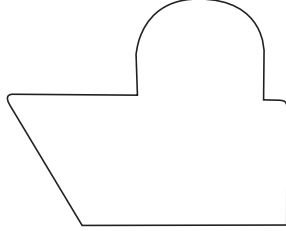
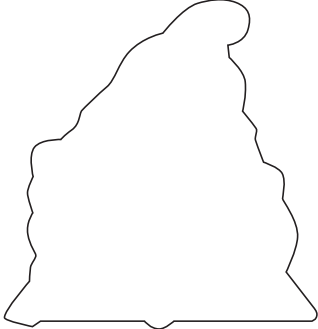
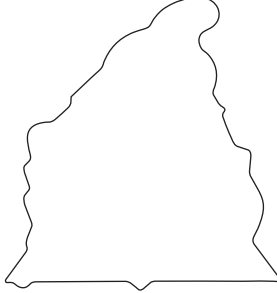
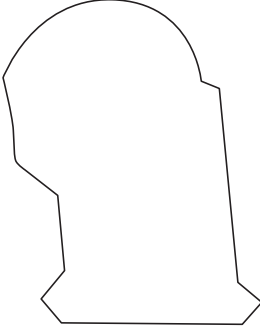
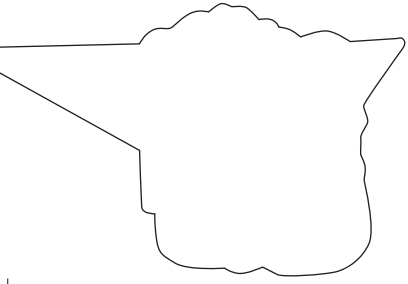
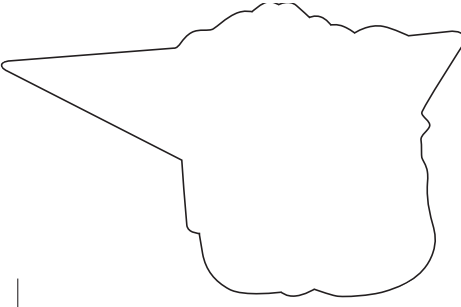
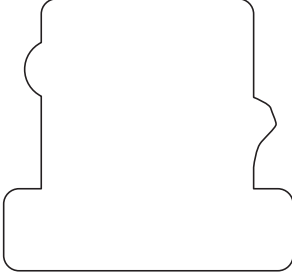
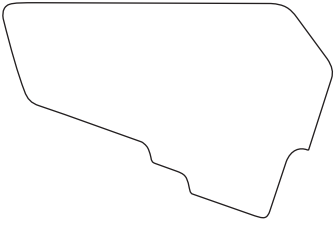
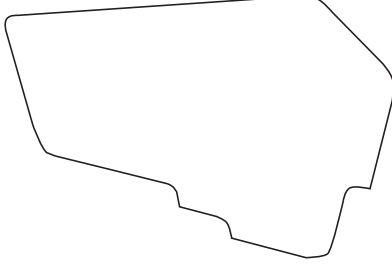
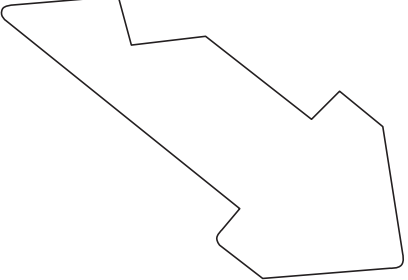
1407	45,9 x 43,6 mm	1381	46,9 x 40 mm	1160	29 x 35 mm
					
1300	43,1 x 40,6 mm	1301	36,9 x 39 mm	1304	42,1 x 31 mm
					
1311	35 x 56 mm	1307	61,5 x 37,7 mm	1305	37,5 x 35,3 mm
					
1329	29 x 44,6 mm	1330	52 x 35,3 mm	1306	62 x 25,3 mm
					

5) Unregelmässige, eckige Figuren

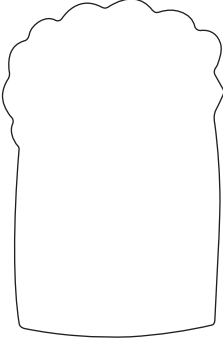
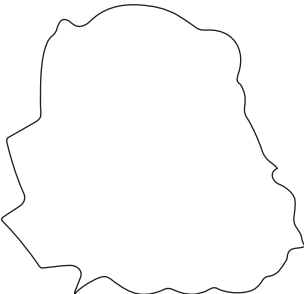
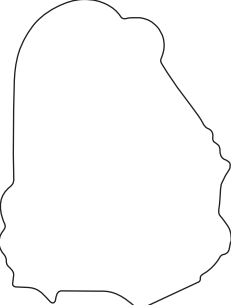
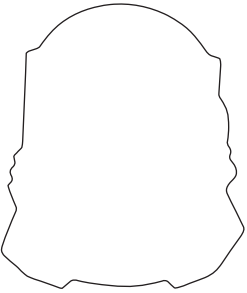
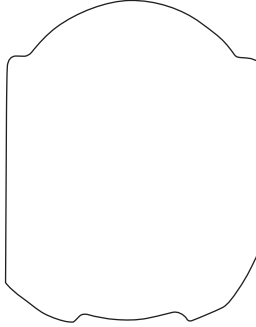
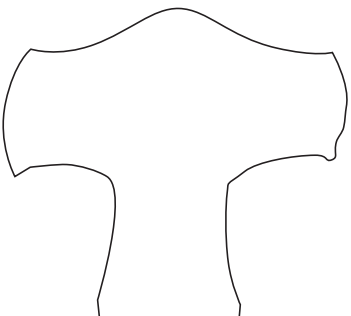
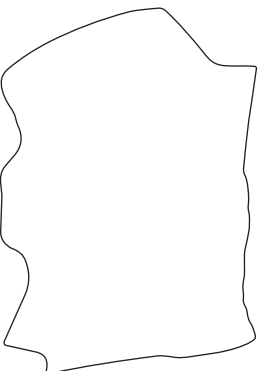
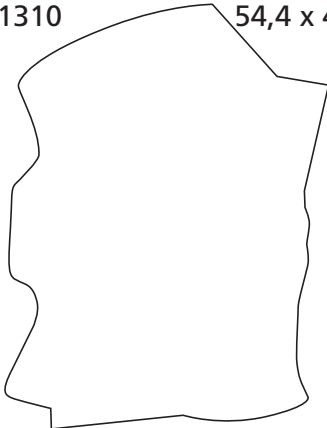
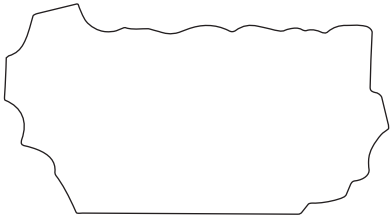
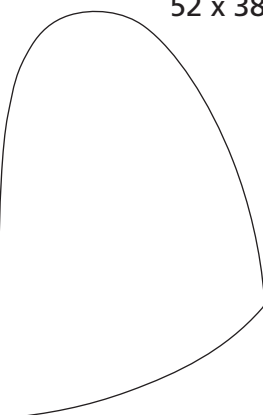
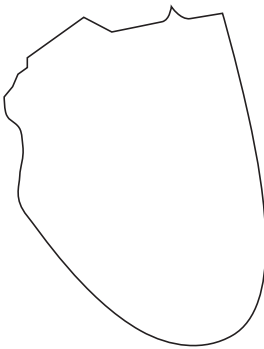
1331	45 x 29 mm	1360	44 x 37,9 mm	1334	42,5 x 31,5 mm
					
1323	38,3 x 32 mm	1324	43 x 34 mm	1194	41,7 x 45,5 mm
					
1309	46,8 x 34,4 mm	1310	54,4 x 40 mm	1335	28,4 x 41,4 mm
					
1332	52 x 38 mm	1333	47 x 32,9 mm		
					

5) Unregelmässige, eckige Figuren

1207	55,4 x 37,6 mm	1208	54,3 x 23,4 mm	1326	53,2 x 27 mm
------	----------------	------	----------------	------	--------------

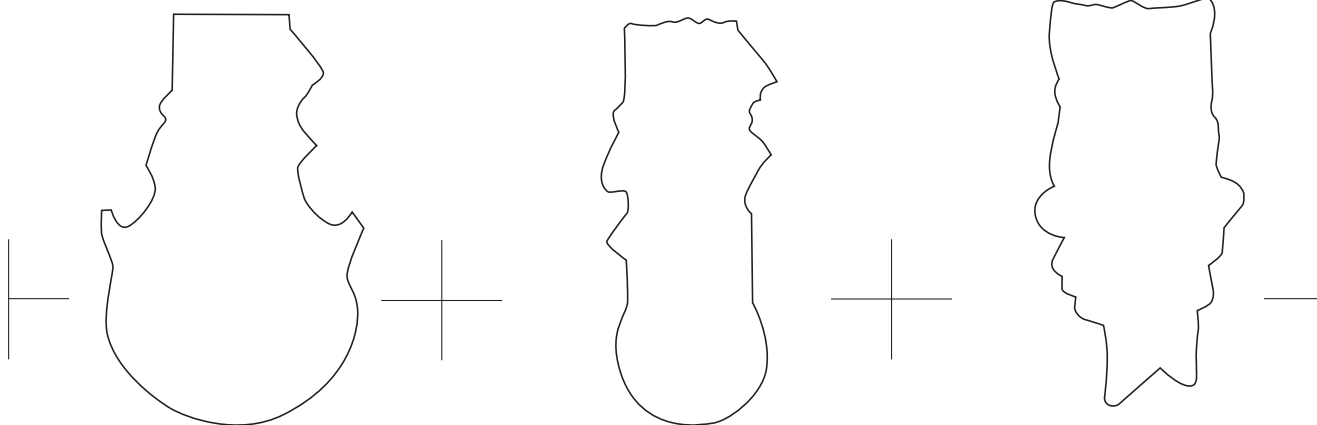

1354	39 x 46,2 mm	1355	36,4 x 45,9 mm	1352	30 x 42,9 mm
------	--------------	------	----------------	------	--------------

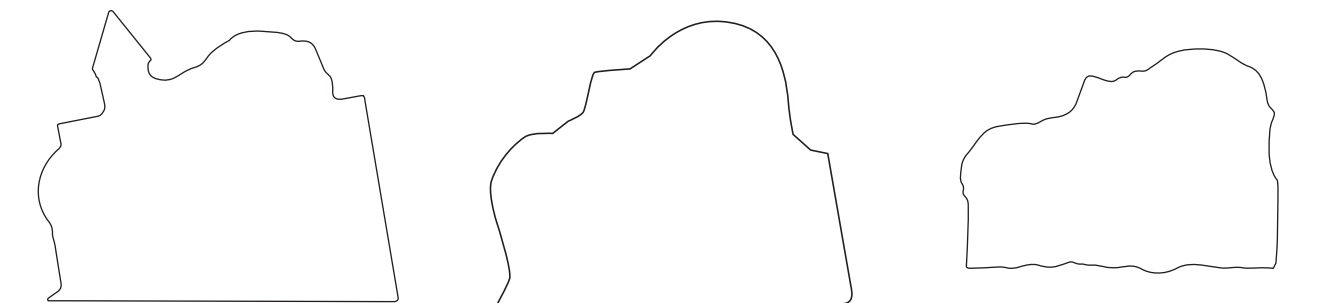

1202	12,8 x 42,7 mm	1204	12,5 x 40,4 mm
------	----------------	------	----------------

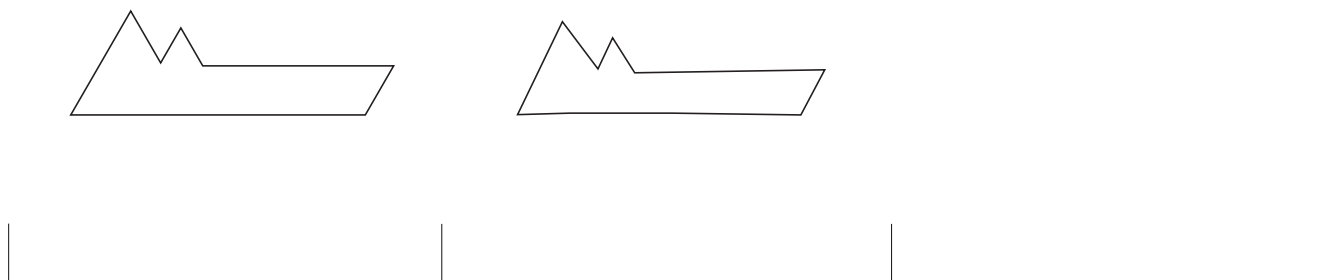



Plaketten

Einfachschnitte:

6) Erkennbare Figuren, Herzen, Wappen usw.

6) Erkennbare Figuren

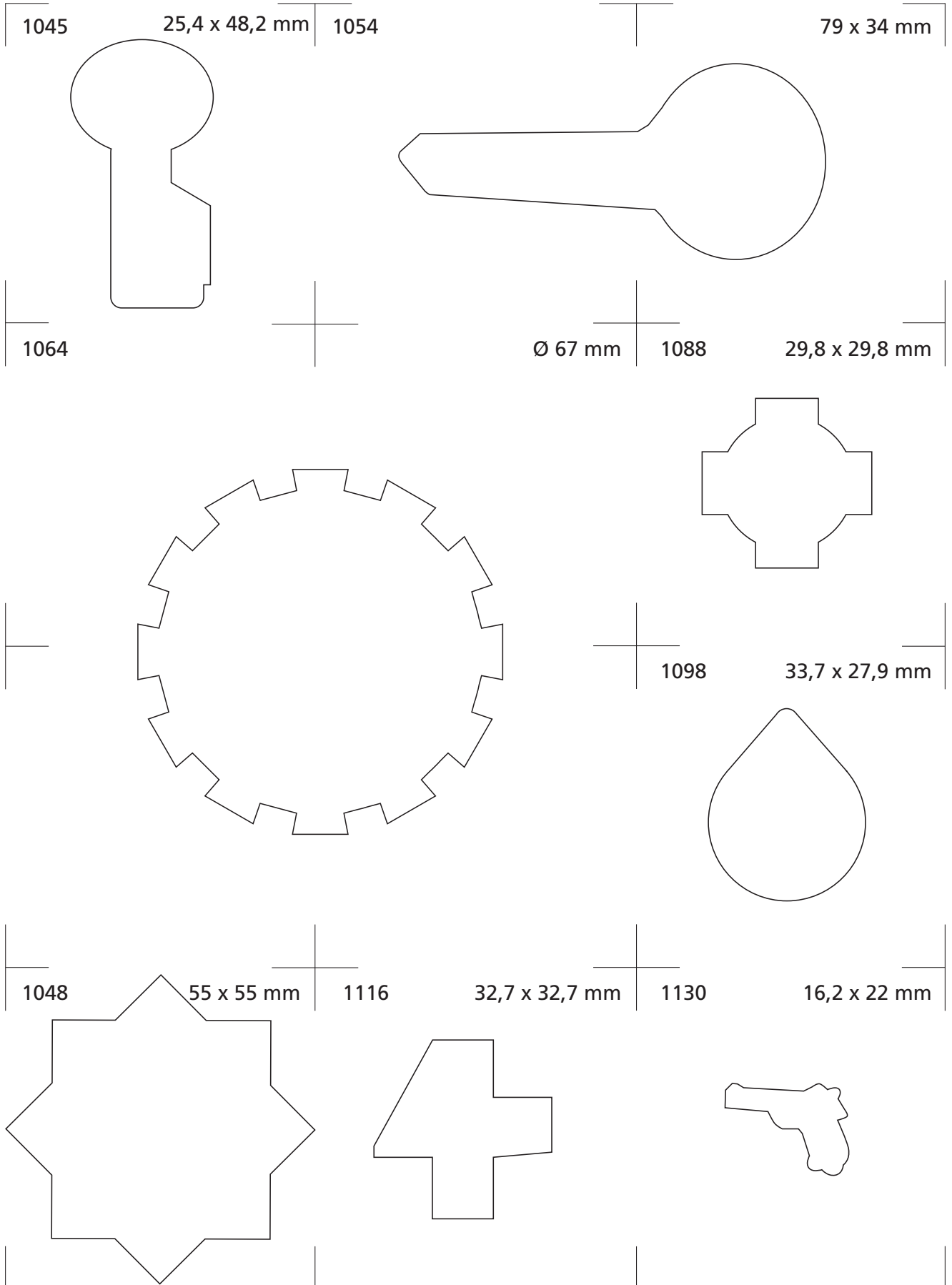

6) Erkennbare Figuren

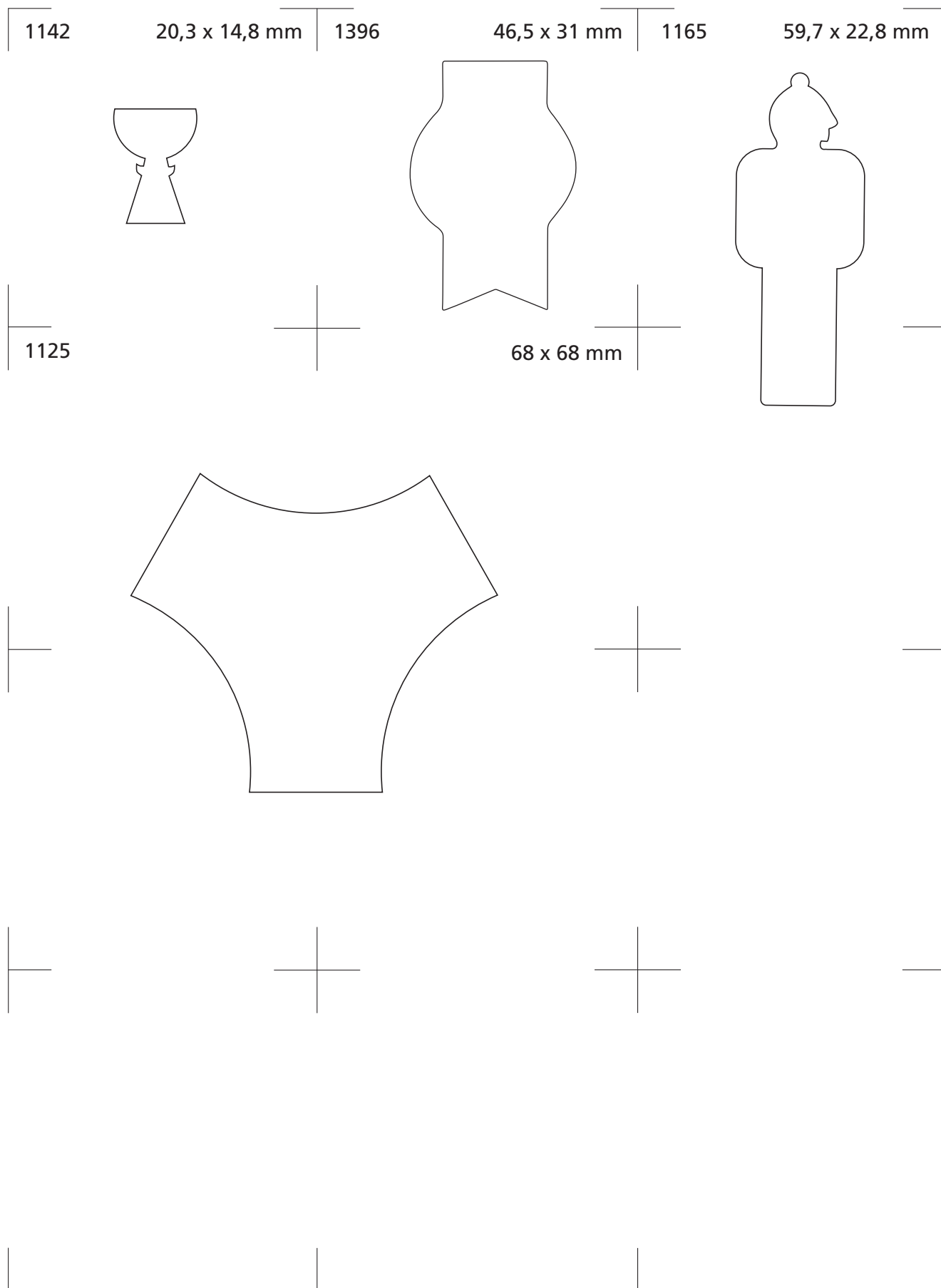

6) Erkennbare Figuren · Herzen

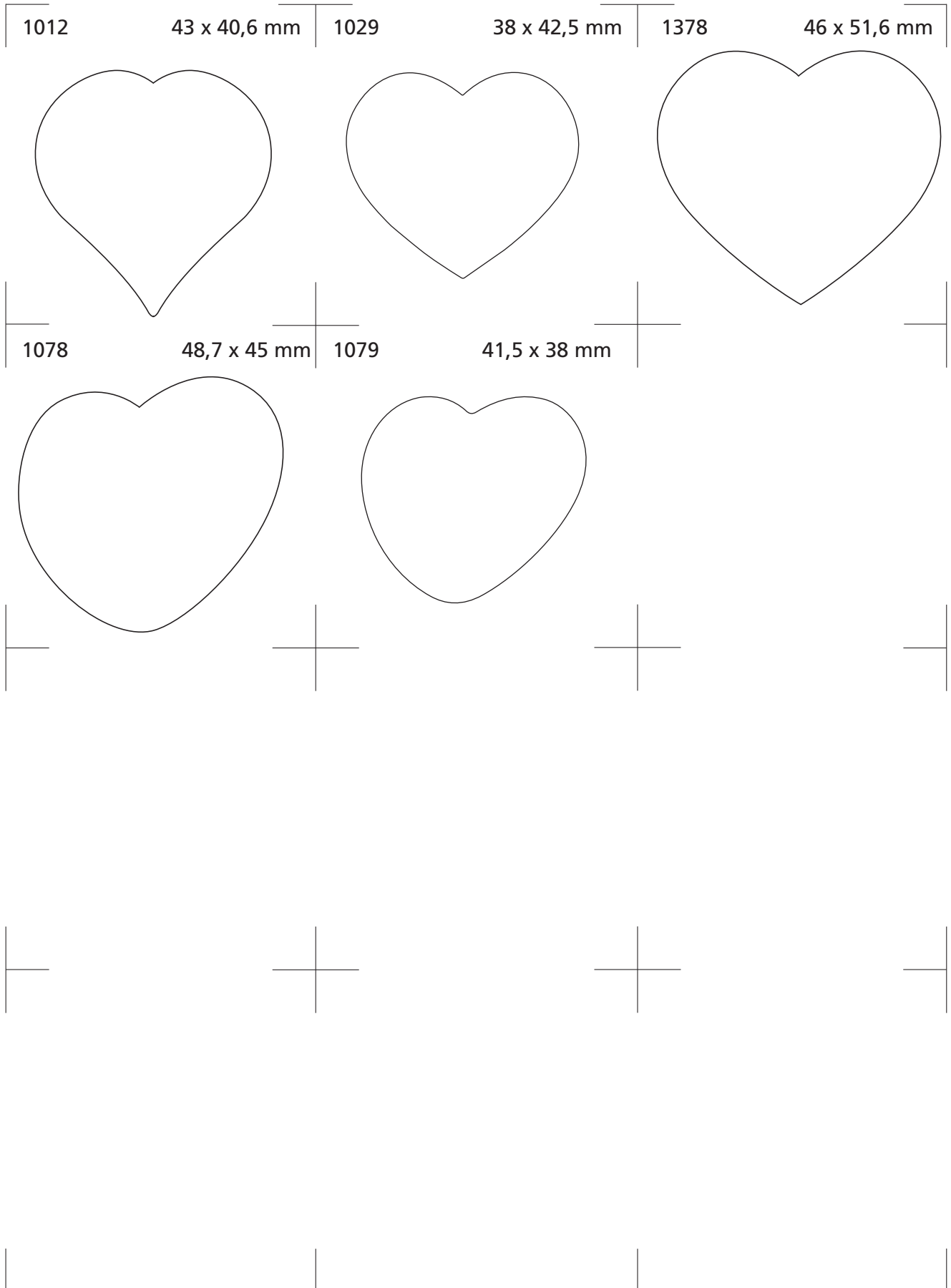

6) Erkennbare Figuren · Wappen und ähnliche

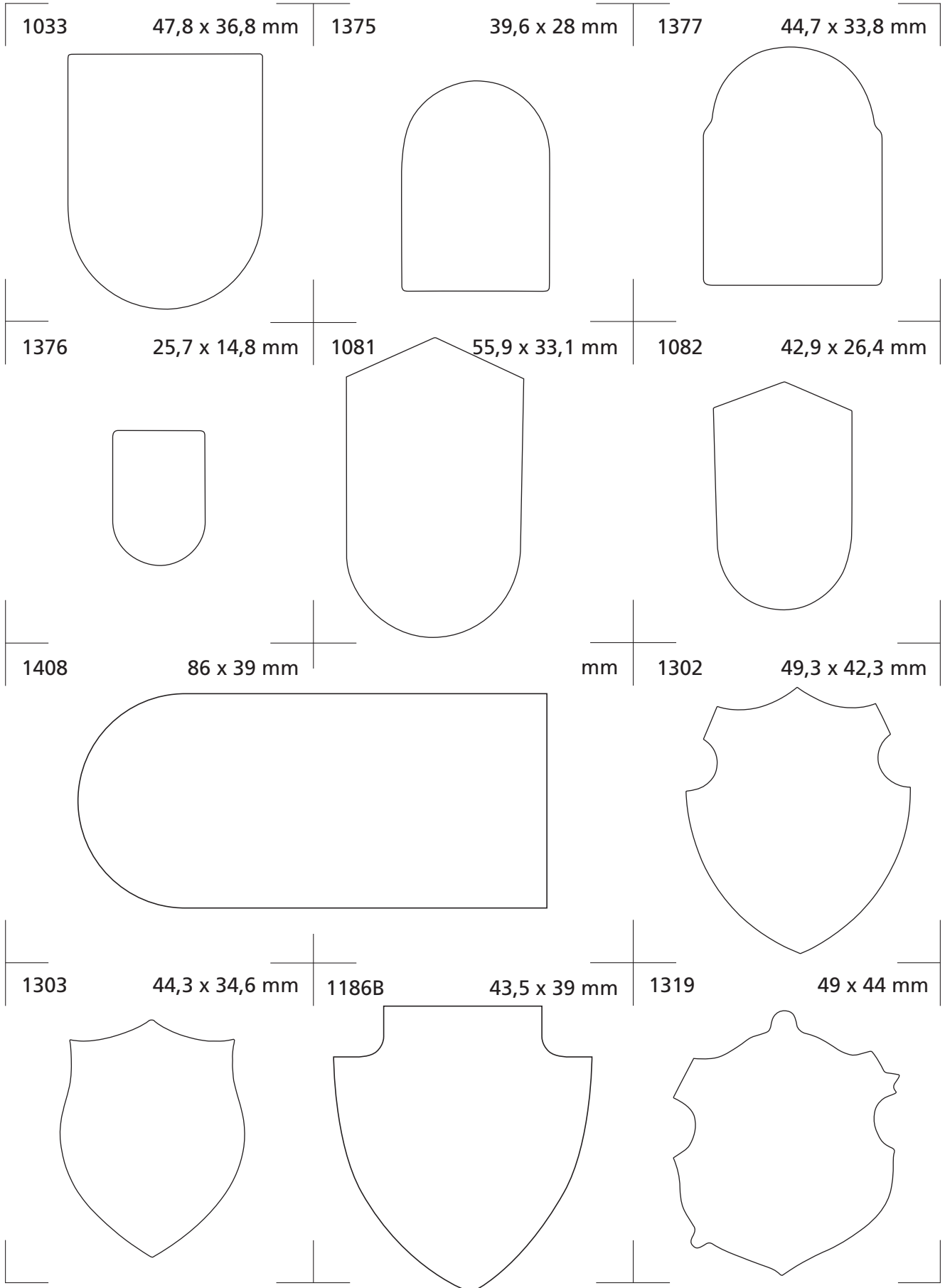

6) Erkennbare Figuren · Wappen und ähnliche

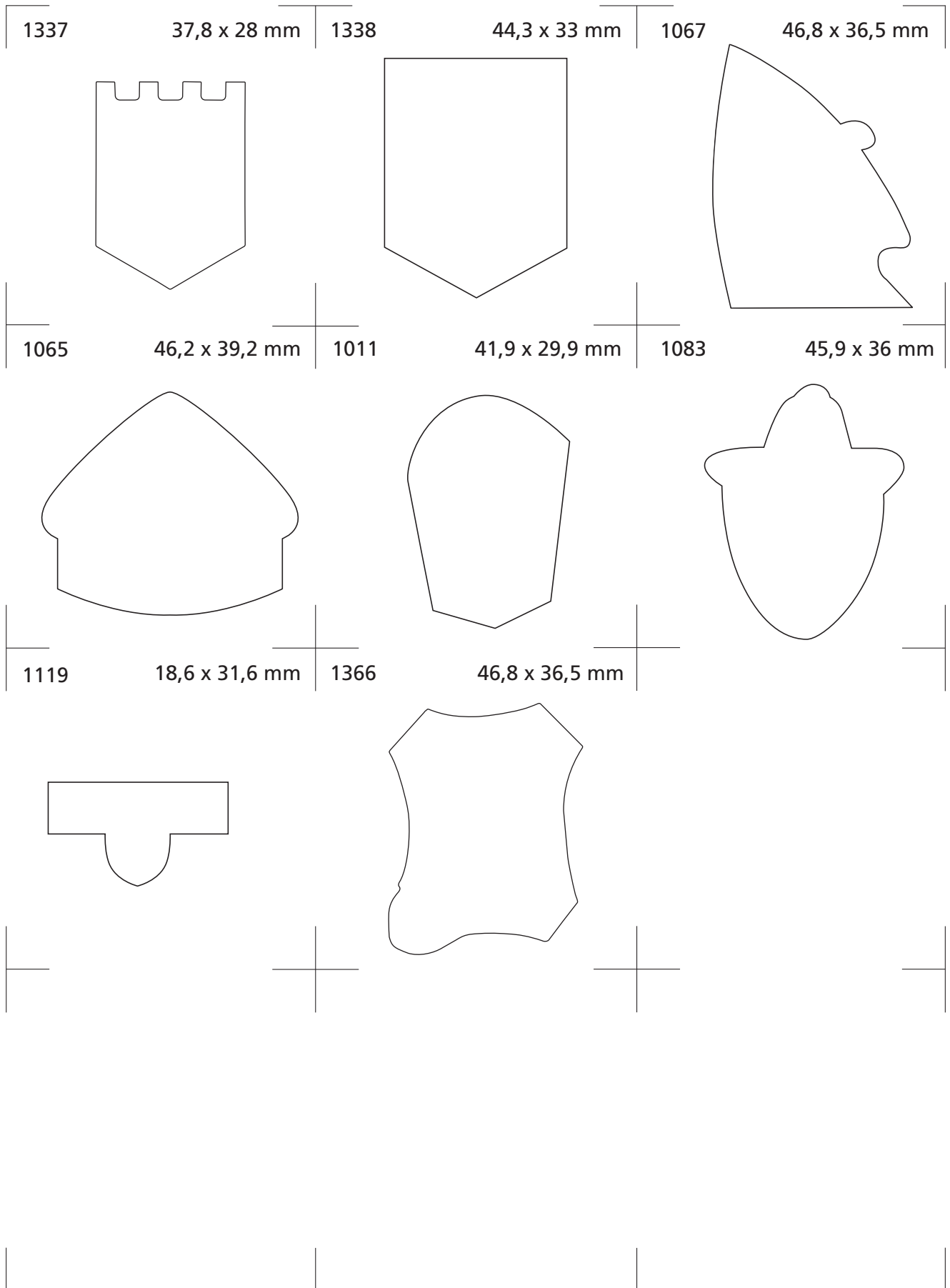



Plaketten

Übersicht Doppelschnitte:

- 1) Ellipsen, Kreise und abgeleitete Figuren

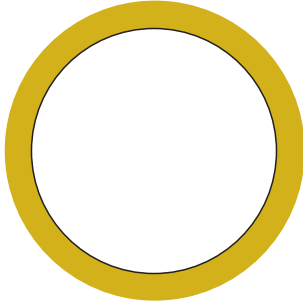
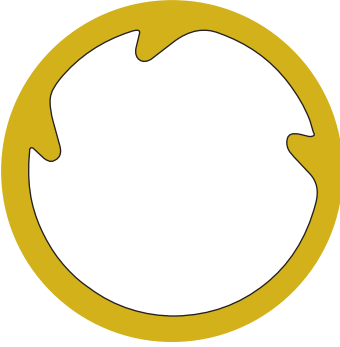
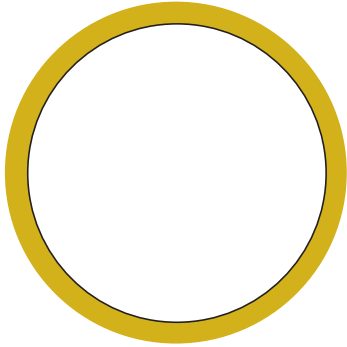
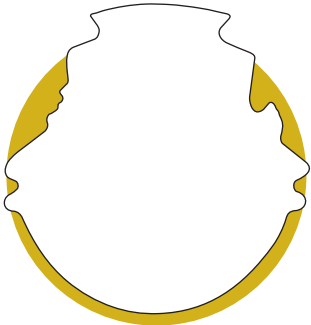
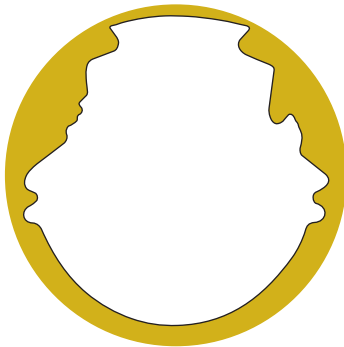
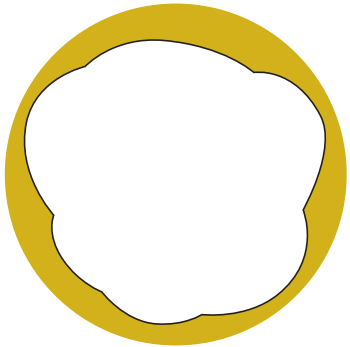
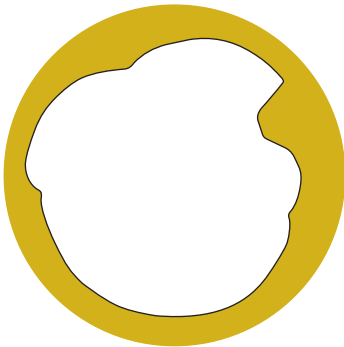
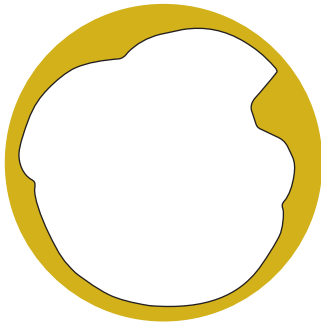
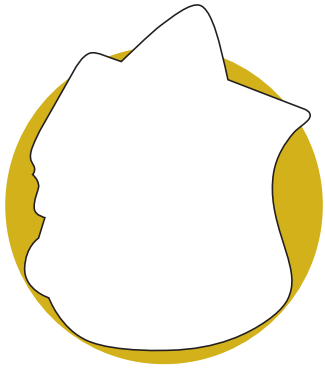
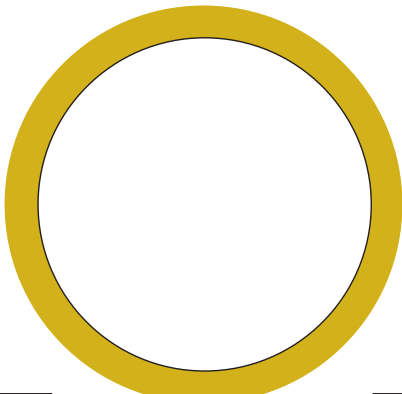
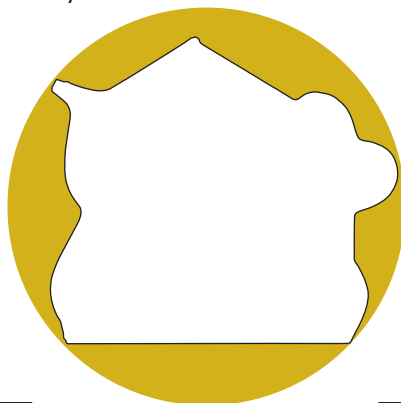
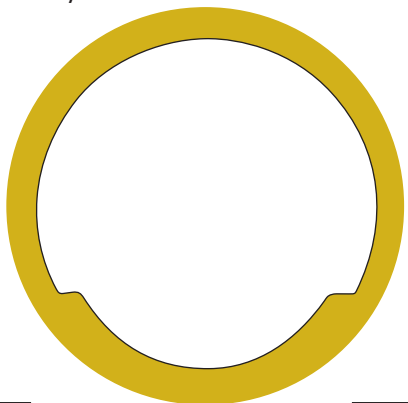

1) Ellipsen, Kreise und abgeleitete Figuren

1345 / 1034	1345.1034.1	1404 / 1356	1404.1356.1	1404 / 1345	1404.1345.1
					
1345 / 1383	1345.1383.1	1404 / 1383	1404.1383.1	1404 / 1313	1404.1313.1
					
1404 / 1371	1404.1371.1	1003 / 1371	1003.1371.1	1003 / 1156	1003.1156.1
					
1022 / 1003	1022.1003.1	1022 / 1103	1022.1103.1	1022 / 1385	1022.1385.1
					

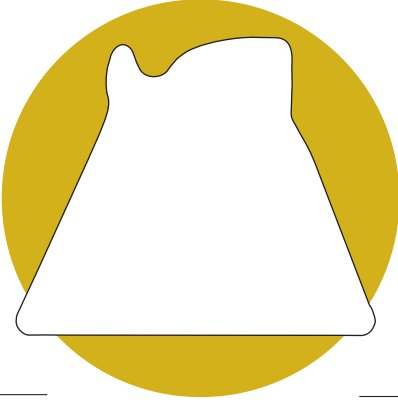
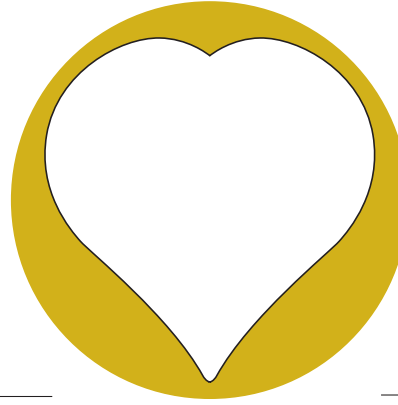
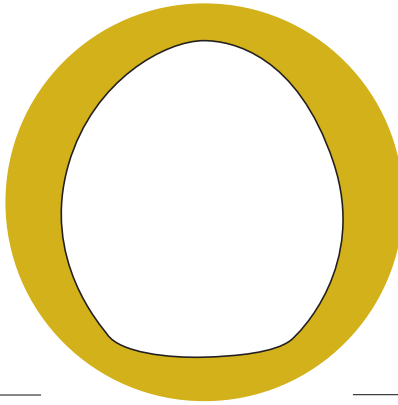
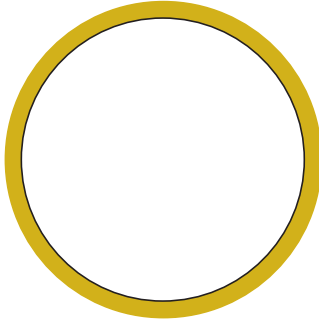
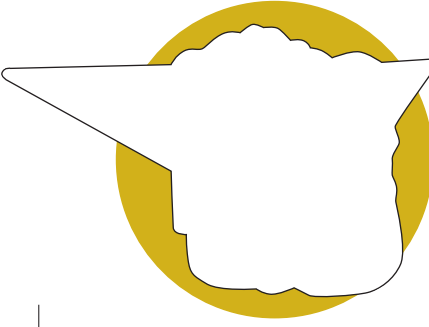
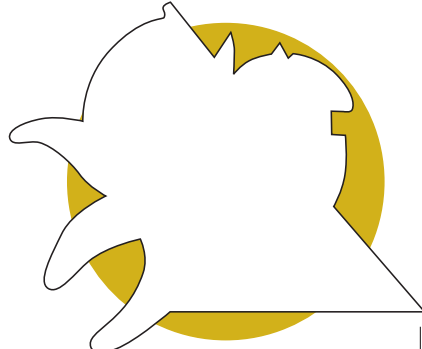
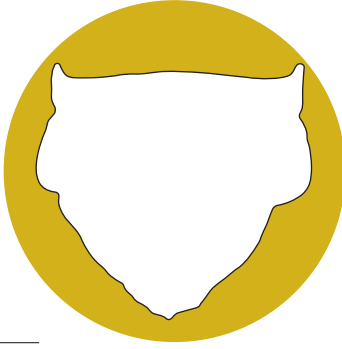
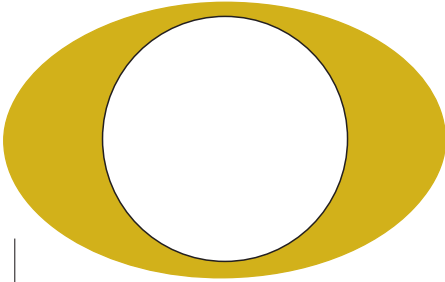
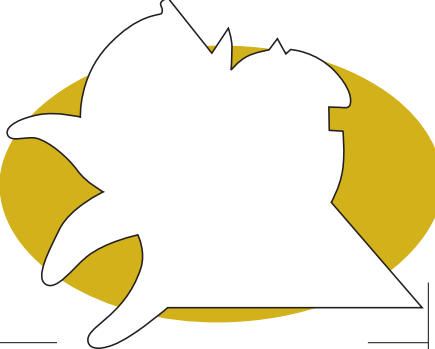
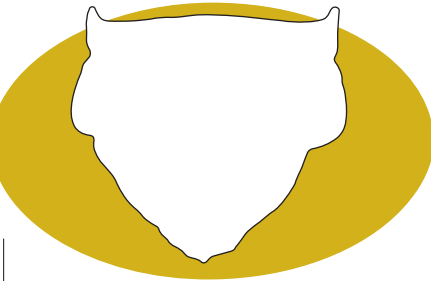
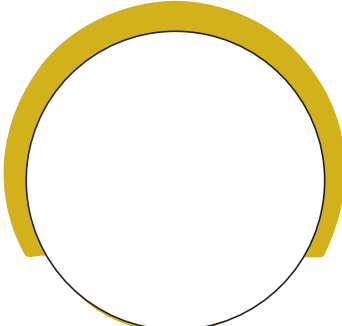
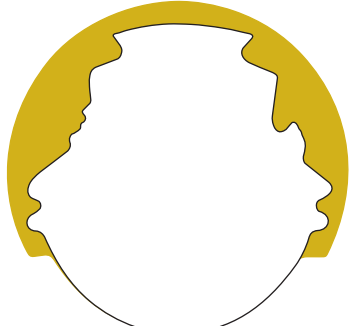
1) Ellipsen, Kreise und abgeleitete Figuren

1022 / 1362	1022.1362.1	1022 / 1012	1022.1012.1	1022 / 1325	1022.1325.1
					
1003 / 1071	1003.1071.1	1003 / 1311	1003.1311.1	1003 / 1219	1003.1219.1
					
1404 / 1370	1404.1370.1	1052 / 1034	1052.1034.1	1034 / 1219	1034.1219.1
					
1034 / 1370	1034.1370.1	1385 / 1345	1385.1345.1	1385 / 1383	1385.1383.1
					

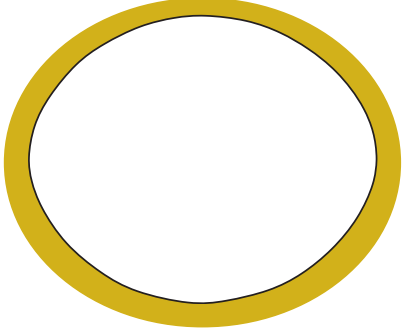
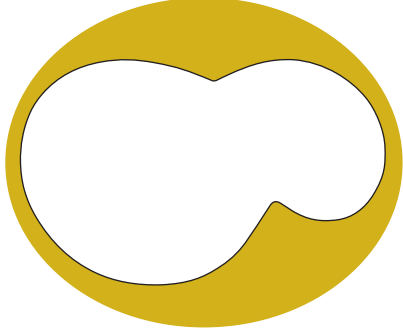
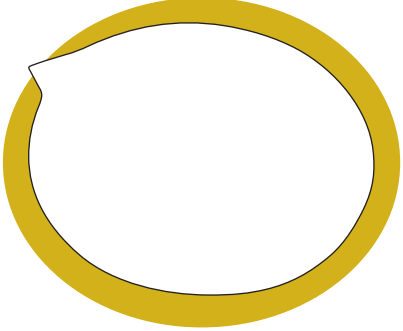
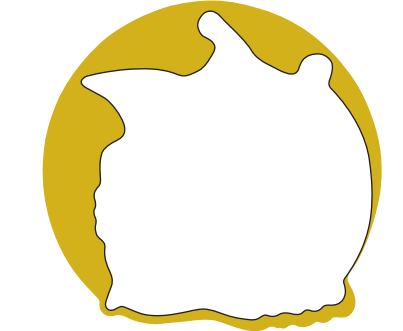
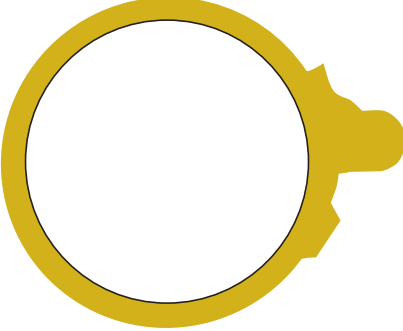
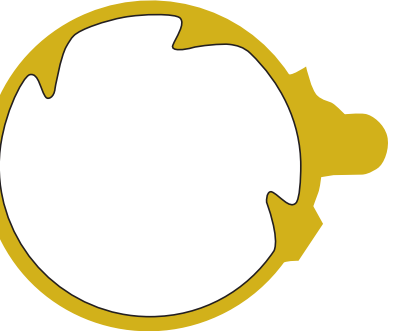
1) Ellipsen, Kreise und abgeleitete Figuren

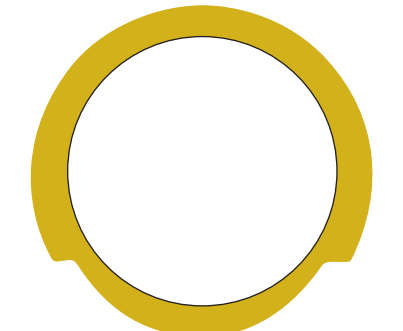
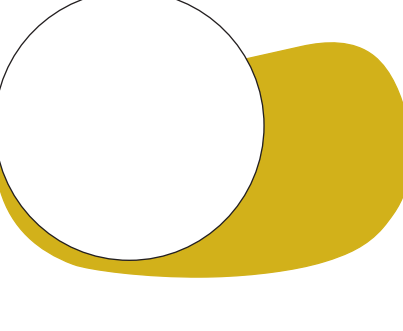
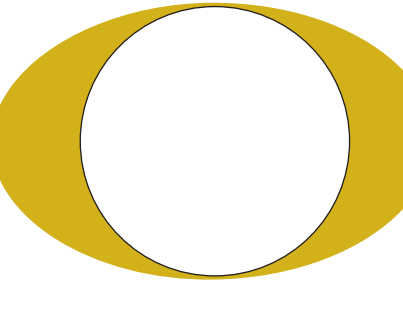
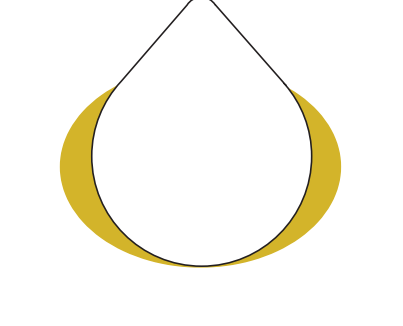
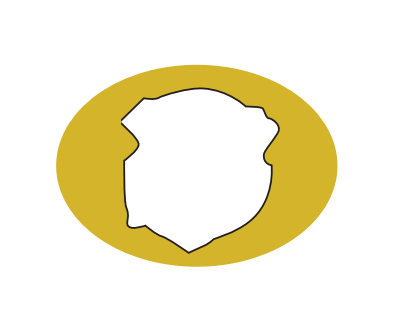
1076 / 1040	1076.1040.1	1076 / 1115	1076.1115.1	1076 / 1060	1076.1060.1
					
1393 / 1391	1393.1391.1	1318 / 1071	1318.1071.1	1318 / 1356	1318.1356.1
					
1385 / 1356	1385.1356.1	1385 / 1409	1385.1409.1	1341 / 1409	1341.1409.1
					
1052 / 1409	1052.1409.1	1410 / 1098	1410.1098.1	1410 / 1320	1410.1320.1
					





Plaketten

Übersicht Doppelschnitte:

2) Vierecke, Rechtecke, Quadrate

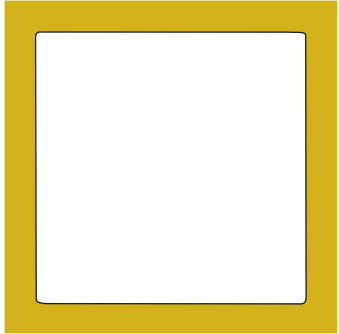
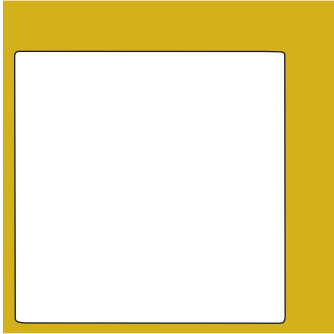
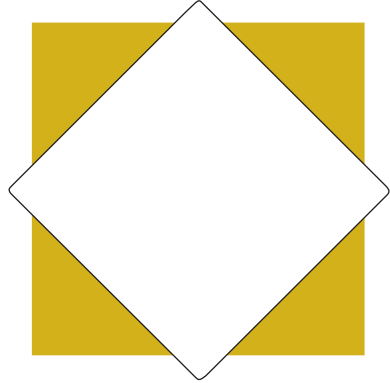
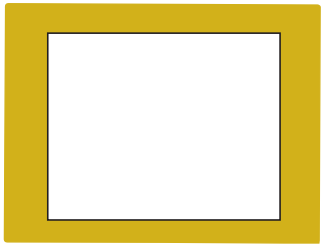
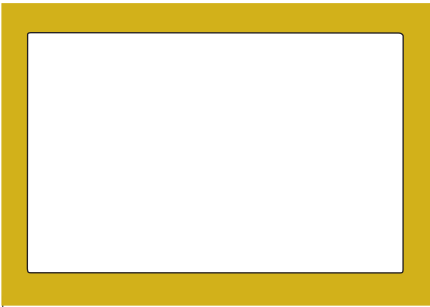
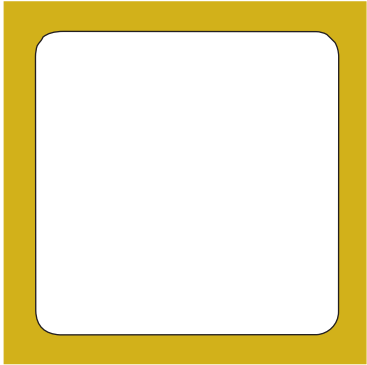
2) Vierecke - Vom Rechteck abgeleitete Figuren

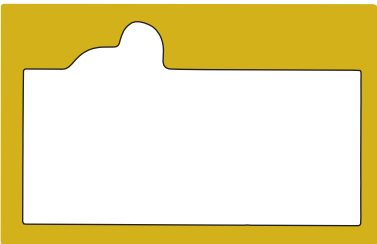
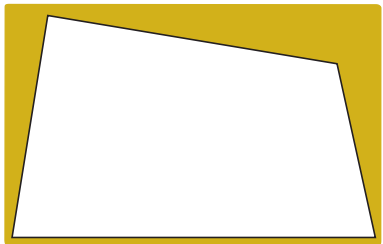
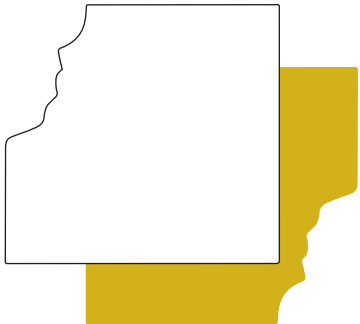
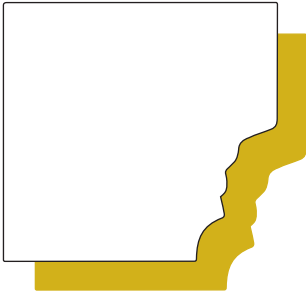
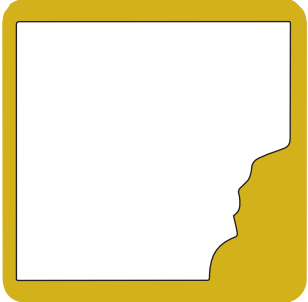
1411/1321	1411.1321.1	1411/1321	1411.1321.2	1411/1321	1411.1321.3
					
1044 / 1372	1044.1372.1	ZS57X40/1001	ZS57X40.1001.1	ZS48X48/1025	ZS48X48.1025.1
					
1001 / 1172	1001.1172.1	1001 / 1211	1001.1211.1	1001 / 1013A	1001.1013A.1
					
1084 / 1084	1084.1084.1	1084 / 1084	1084.1084.2	1025 / 1084	1025.1084.1
					

2) Vierecke - Vom Rechteck abgeleitete Figuren

1025 / 1014A	1025.1014A.1	1025 / 1035	1025.1035.1	1017 / 1017	1017.1017.1
					
1017 / 1151	1017.1151.1	1017 / 1403	1017.1403.1		
					
1032 / 1083	1032.1083.1	1032 / 1157	1032.1157.1	1032 / 1124	1032.1124.1
					
1135 / 1013B	1135.1013B.1	1135 / 1035	1135.1035.1	1135 / 1037	1135.1037.1
					

2) Vierecke - Vom Rechteck abgeleitete Figuren

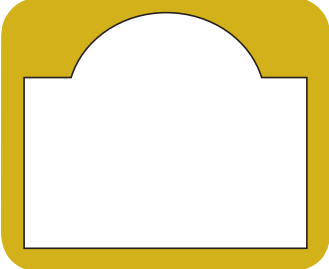
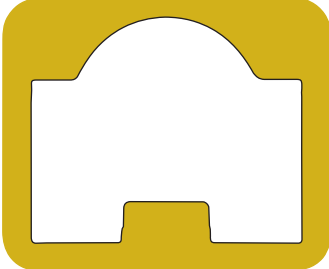
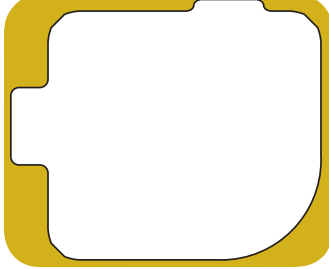
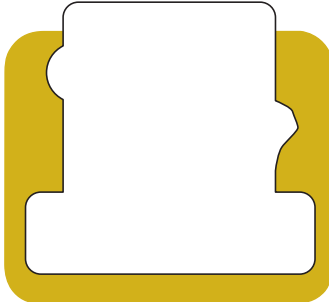
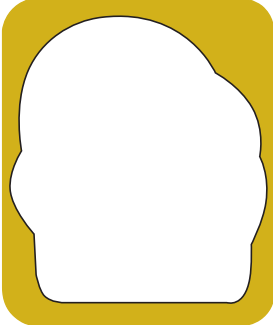
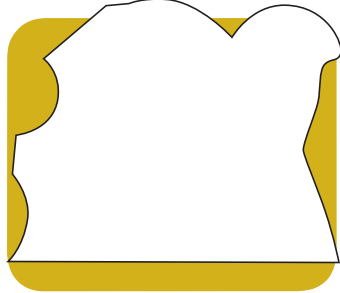
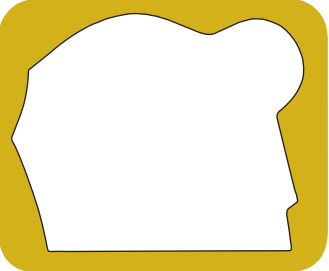
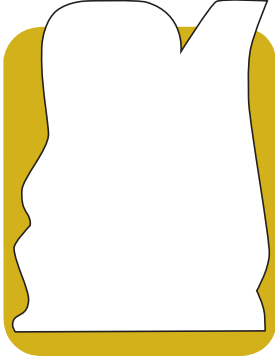
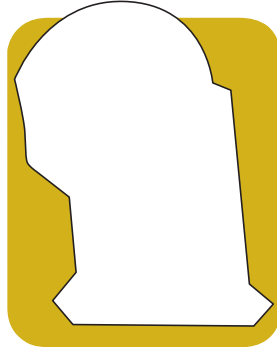
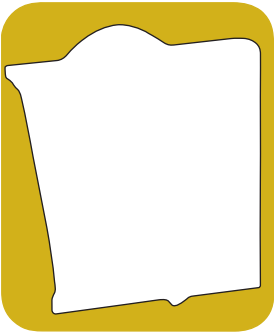
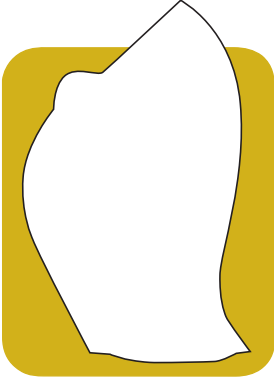
1135 / 1085	1135.1085.1	1135 / 1042	1135.1042.1	1135 / 1136	1135.1136.1
					
1135 / 1305	1135.1305.1	1135 / 1167	1135.1167.1	1135 / 1124	1135.1124.1
					
1135 / 1133	1135.1133.1	1135 / 1155	1135.1155.1	1135 / 1304	1135.1304.1
					
1135 / 1179	1135.1179.1	1135 / 1181	1135.1181.1		
					

2) Vierecke - Vom Rechteck abgeleitete Figuren

1199 / 1131 1199.1131.1 1199 / 1043 1199.1043.1

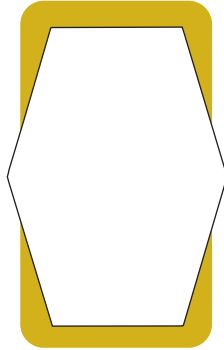

1106 / 1047 1106.1047.1

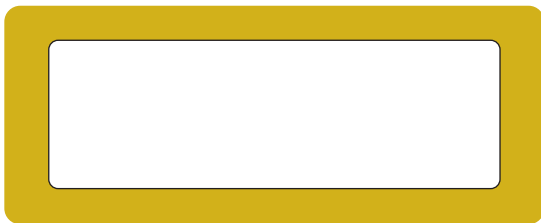

1174 / 1044 1174.1044.1

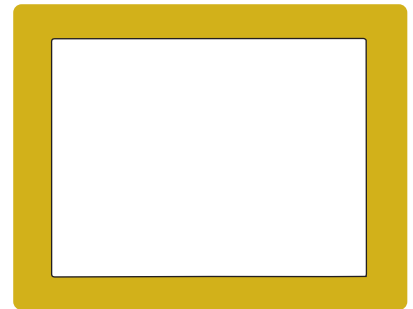

1200 / 1212 1200.1212.1 1200 / 1211 1200.1211.1 1200 / 1200 1200.1200.1

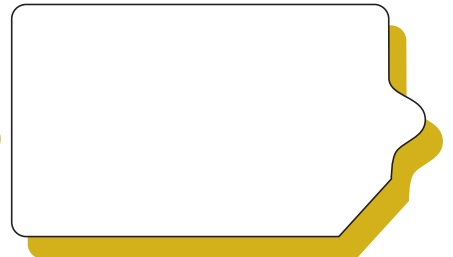
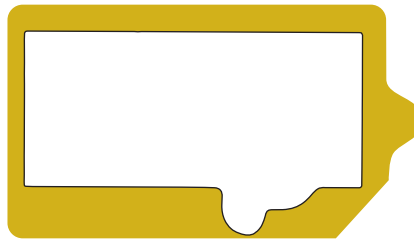
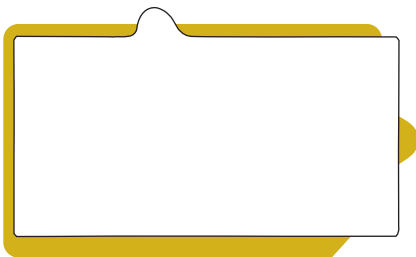

1050 / 1050 1050.1050.1 1050 / 1050 1050.1050.2 1050 / 1050 1050.1050.3

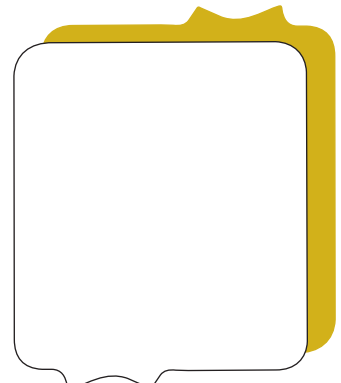
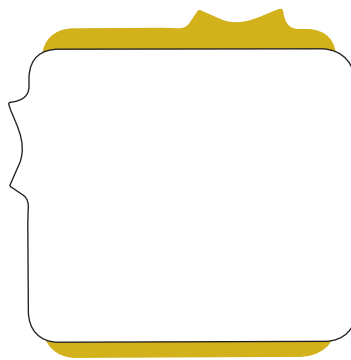
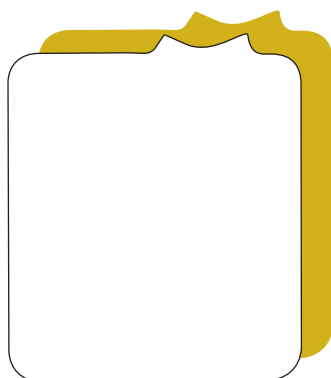

2) Vierecke - Vom Rechteck abgeleitete Figuren

1085 / 1085	1085.1085.1	1085 / 1042	1085.1042.1	1085 / 1085	1085.1085.2
-------------	-------------	-------------	-------------	-------------	-------------

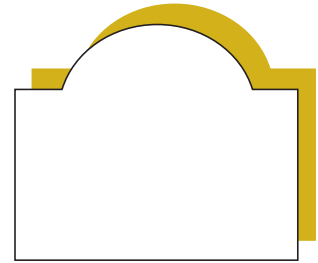
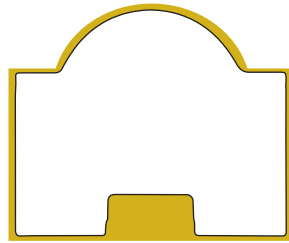
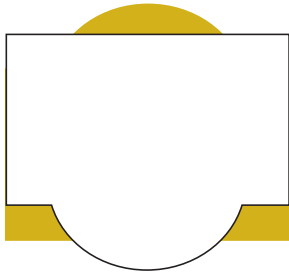

1102 / 1102	1102.1102.1	1102 / 1102	1102.1102.2	1102 / 1102	1102.1102.3
-------------	-------------	-------------	-------------	-------------	-------------

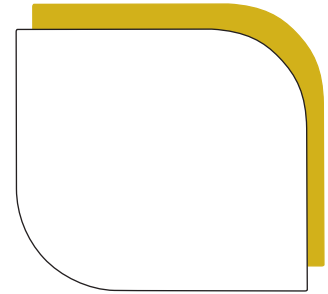
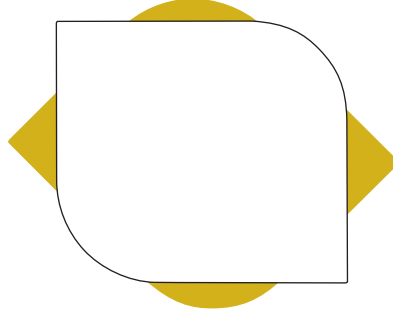
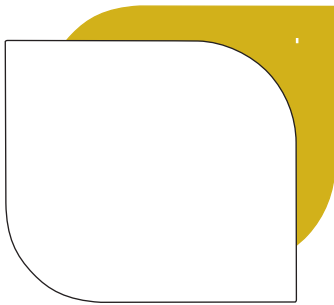

1105K / 1105K	1105K.1105K.1	1105K / 1105K	1105K.1105K.4	1095 / 1095	1095.1095.1
---------------	---------------	---------------	---------------	-------------	-------------

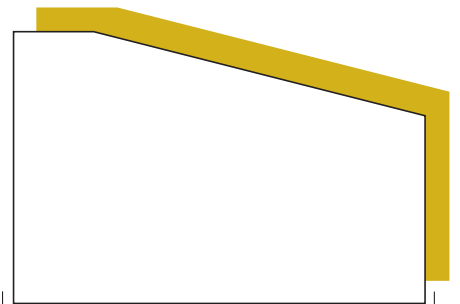
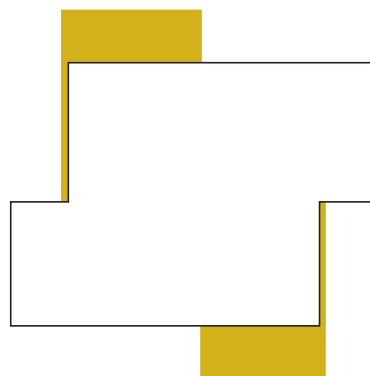
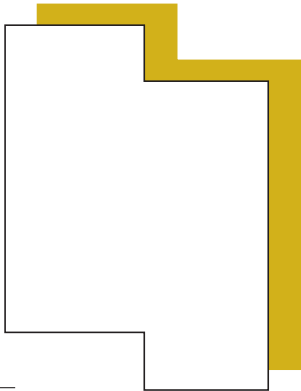

2) Vierecke - Vom Rechteck abgeleitete Figuren

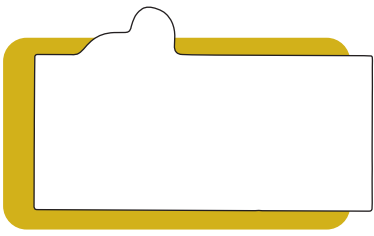
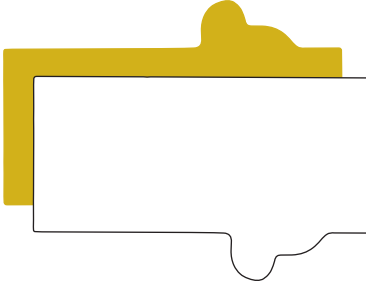
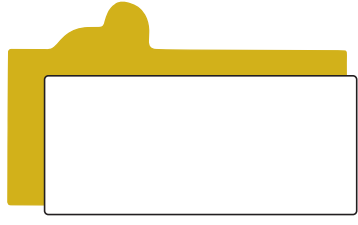
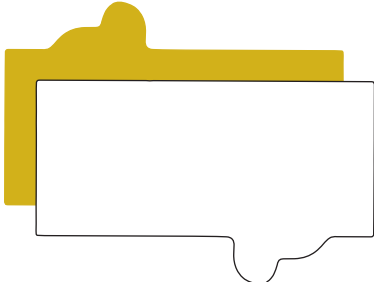
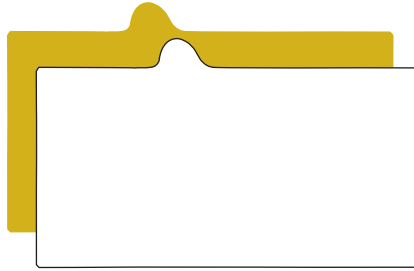
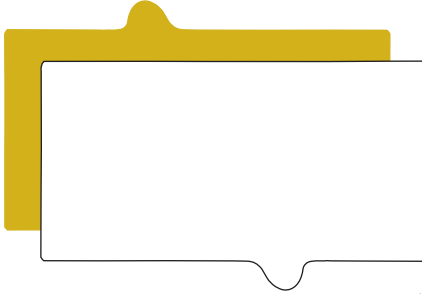
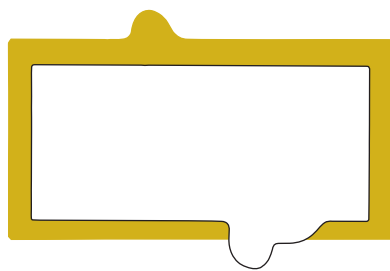
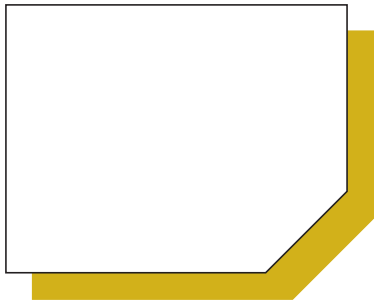
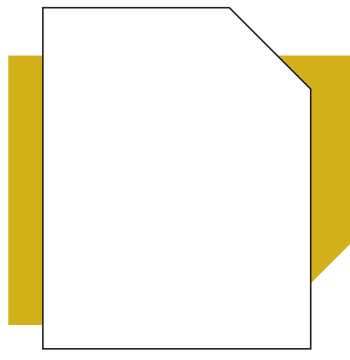
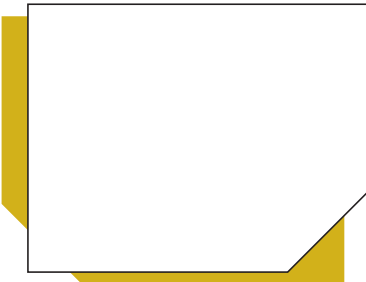
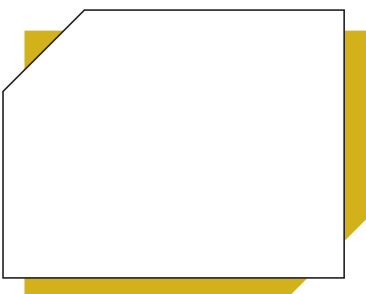
1199 / 1211	1199.1211.1	1211 / 1211	1211.1211.1	1211 / 1131	1211.1131.1
					
1211 / 1211	1211.1211.2	1212 / 1212	1212.1212.1	1212 / 1212	1212.1212.2
					
1212 / 1211	1212.1211.1	1097 / 1097	1097.1097.1	1097 / 1097	1097.1097.2
					
1097 / 1097	1097.1097.5	1097 / 1097	1097.1097.6		
					

2) Vierecke - Vom Rechteck abgeleitete Figuren

1035 / 1035 1035.1035.1 1035 / 1035 1035.1035.2 1035 / 1035 1035.1035.3

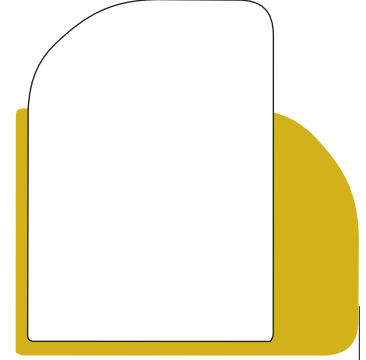
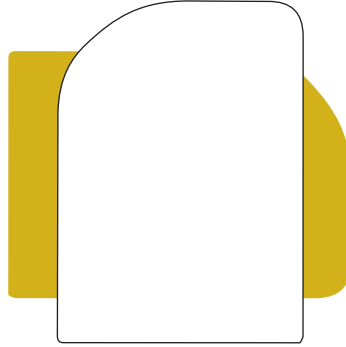
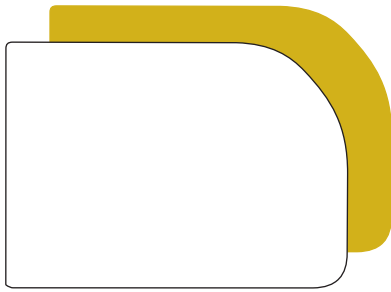

1035 / 1035 1035.1035.4 1035 / 1035 1035.1035.5 1038 / 1001 1038.1001.1

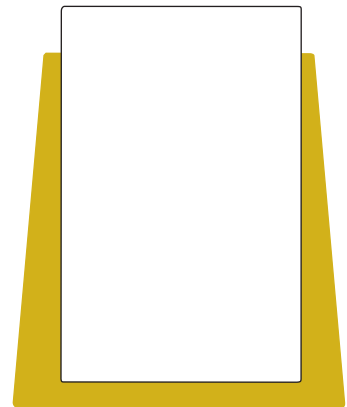
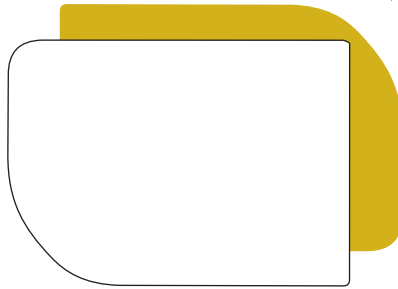
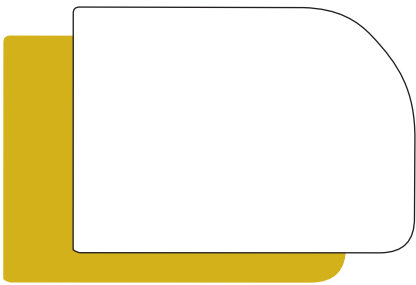

1336 / 1336 1336.1336.1

1336 / 1395 1336.1395.1

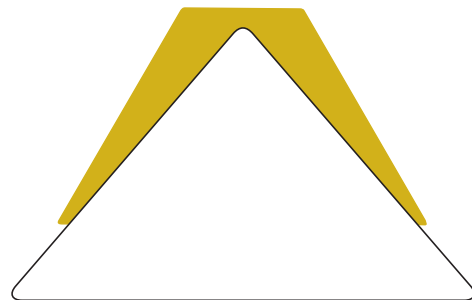
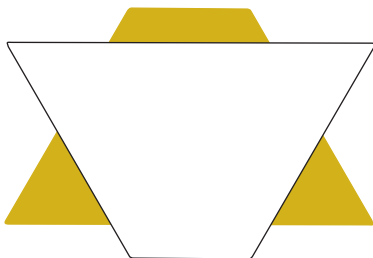



Plaketten

Übersicht Doppelschnitte:

3) Dreiecke - Polygone (Vielecke)

3) Dreiecke und Polygone (Vielecke)

1209 / 1209	1209.1209.1	1209 / 1209	1209.1209.2	1210 / 1209	1210.1209.1
-------------	-------------	-------------	-------------	-------------	-------------

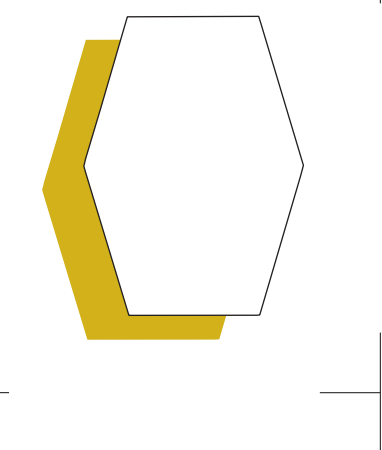
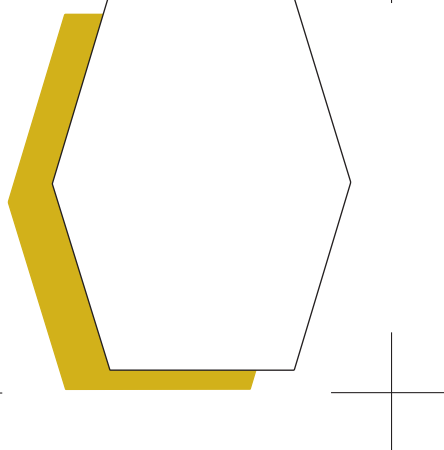
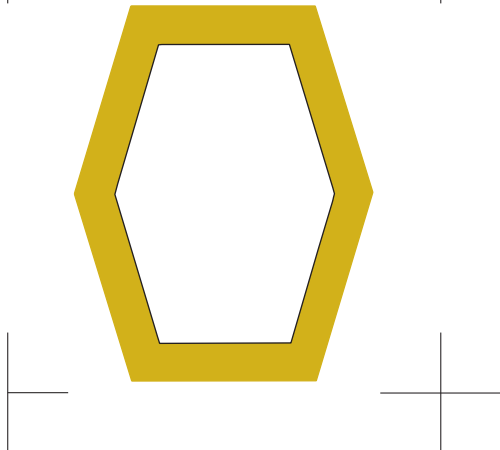
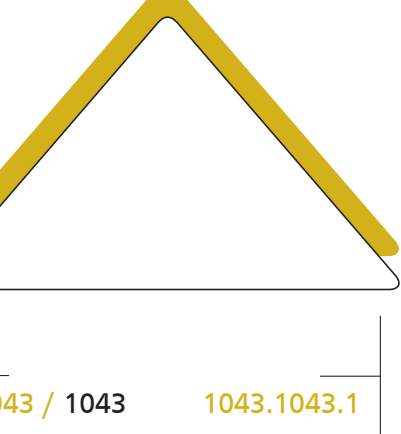
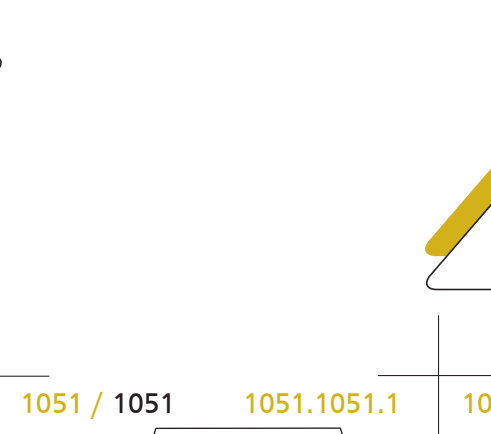
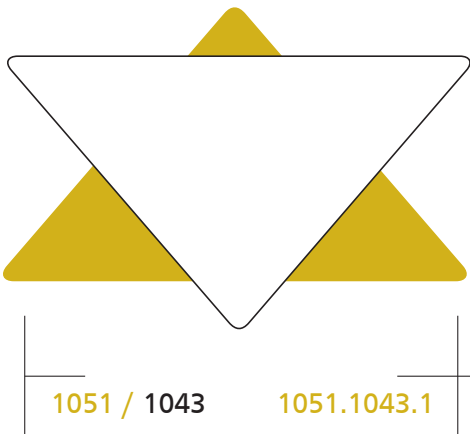
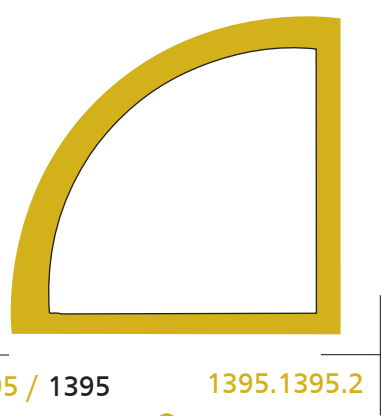
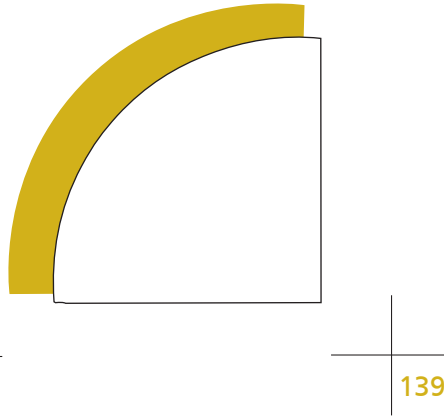
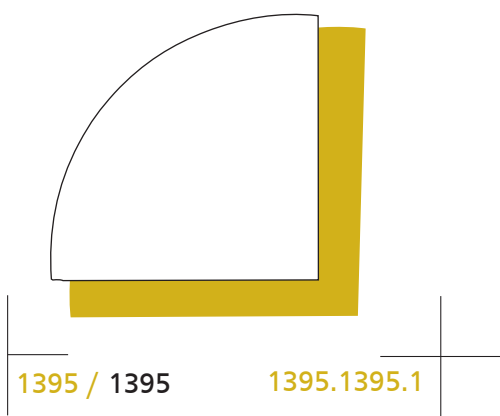

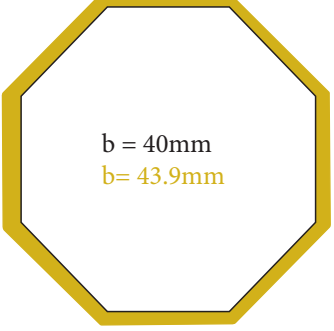
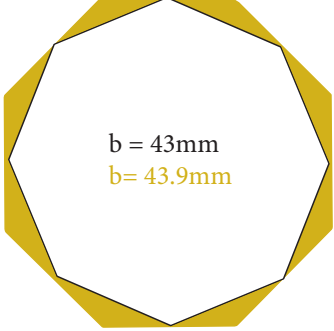
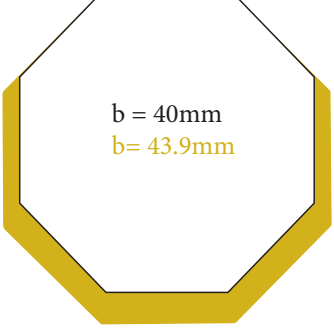
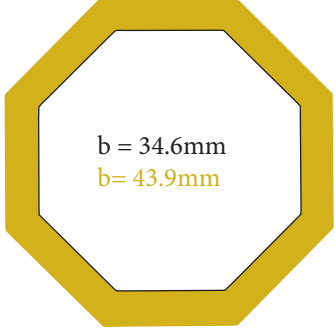
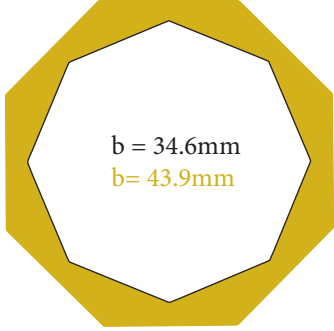
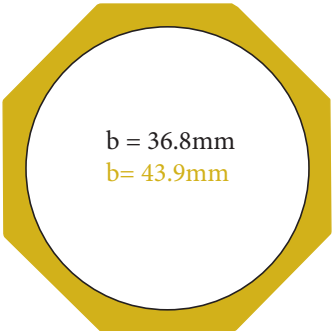
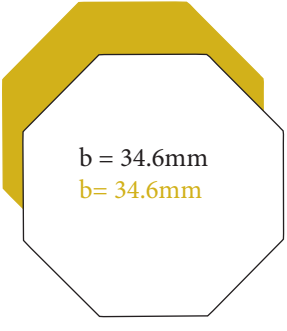
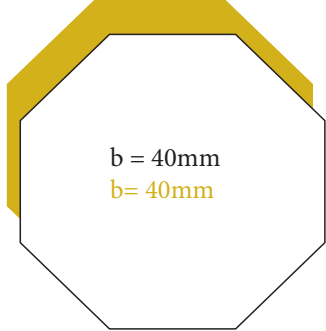
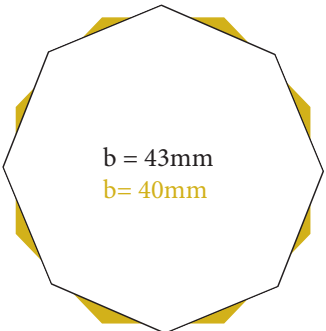
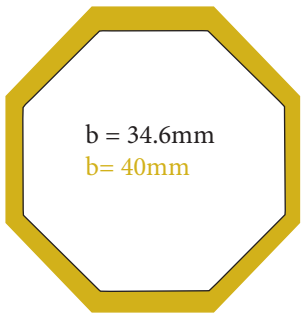
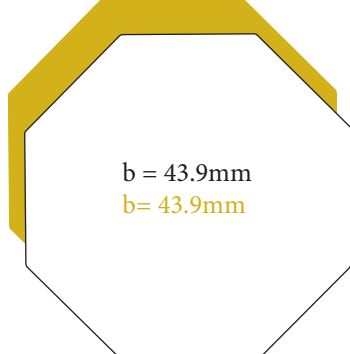
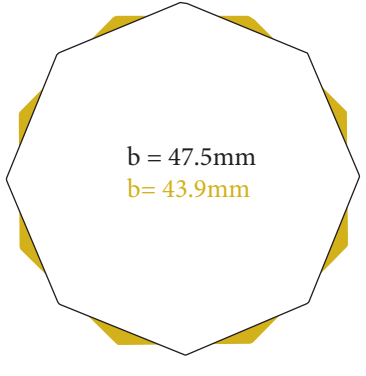
1137 / 1049	1137.1049.1	1137 / 1049	1137.1049.2	1137 / 1049	1137.1049.3
					
1137 / 1089	1137.1089.1	1137 / 1089	1137.1089.2	1137 / 1071	1137.1071.1
					
1089 / 1089	1089.1089.1	1049 / 1049	1049.1049.1	1049 / 1049	1049.1049.2
					
1049 / 1089	1049.1089.1	1137 / 1137	1137.1137.1	1137 / 1037	1137.1037.2
					

3) Polygone (Vielecke)

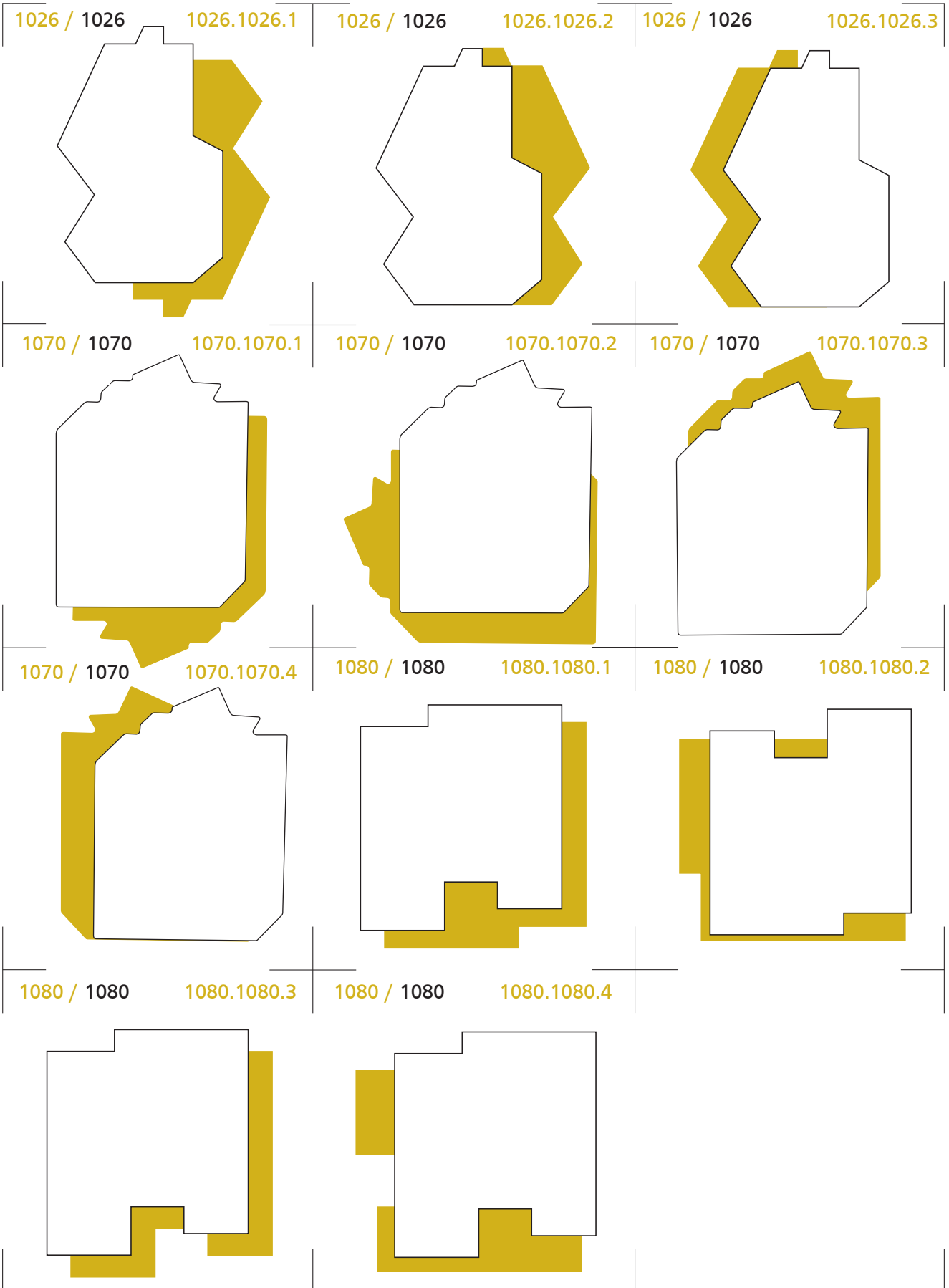



Plaketten

Übersicht Doppelschnitte:

4) unregelmässige, gerundete Figuren

4) Unregelmässige, gerundete Figuren

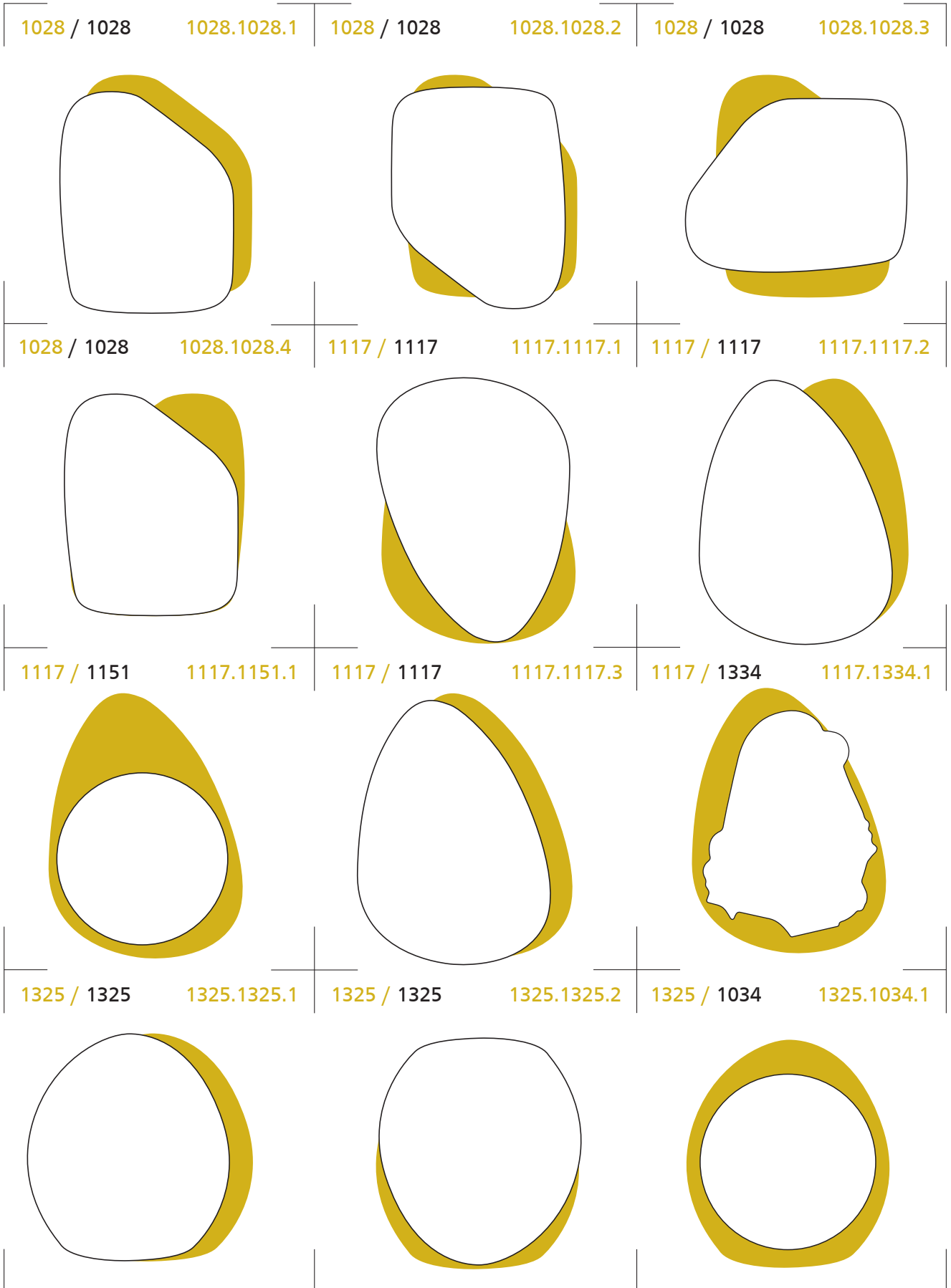

4) Unregelmässige, gerundete Figuren

1340 / 1340	1340.1340.1	1340 / 1340	1340.1340.2	1340 / 1340	1340.1340.3
-------------	-------------	-------------	-------------	-------------	-------------

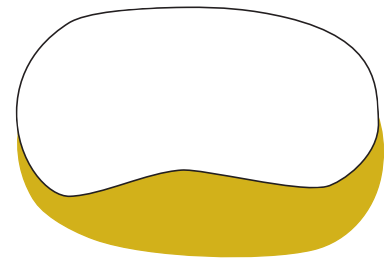
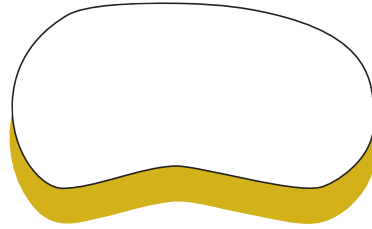
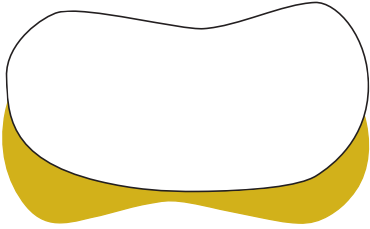

1341 / 1340	1341.1340.1	1341 / 1340	1341.1340.2	1341 / 1340	1341.1340.3
-------------	-------------	-------------	-------------	-------------	-------------

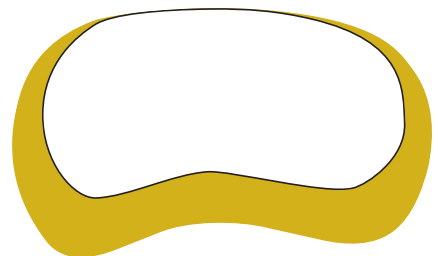
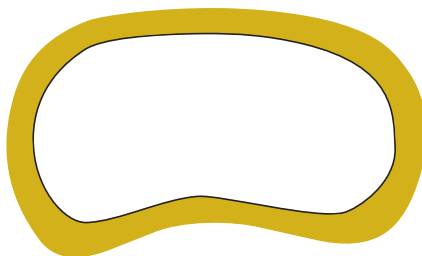
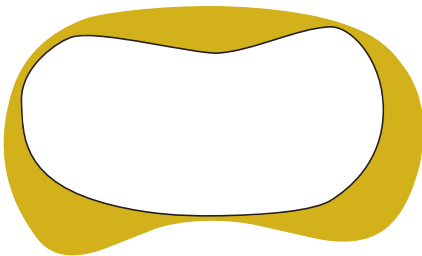

1115 / 1115	1115.1115.1	1115 / 1115	1115.1115.2	1115 / 1115	1115.1115.3
-------------	-------------	-------------	-------------	-------------	-------------

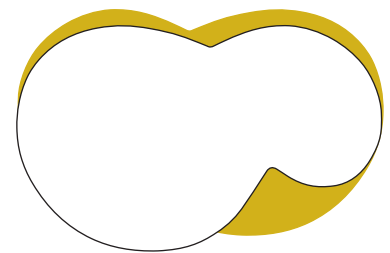
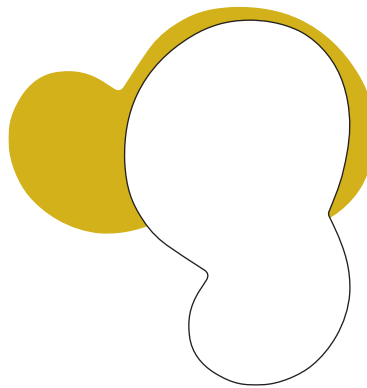
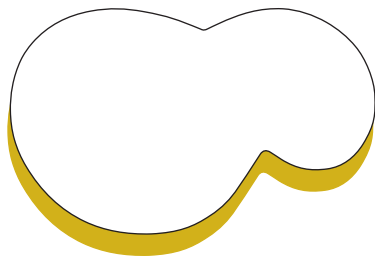

--	--	--	--	--	--

--	--	--	--	--	--

4) Unregelmässige, gerundete Figuren

1312 / 1312	1312.1312.1	1312 / 1312	1312.1312.2	1312 / 1030	1312.1030.1
-------------	-------------	-------------	-------------	-------------	-------------

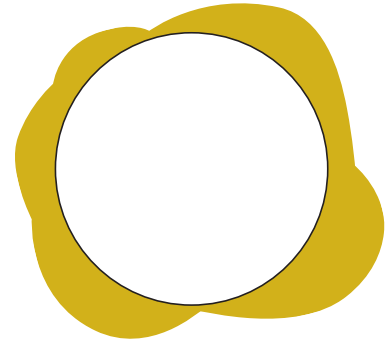
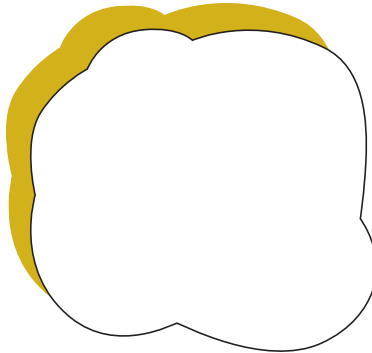
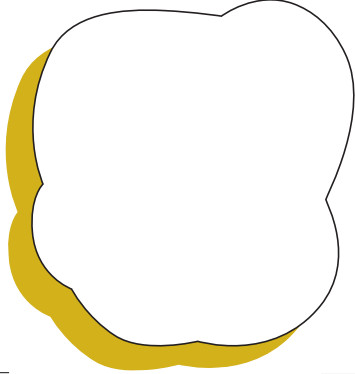

1312 / 1307	1312.1307.1	1313 / 1313	1313.1313.1	1313 / 1311	1313.1311.1
-------------	-------------	-------------	-------------	-------------	-------------

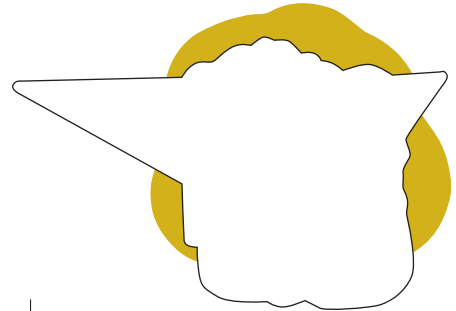
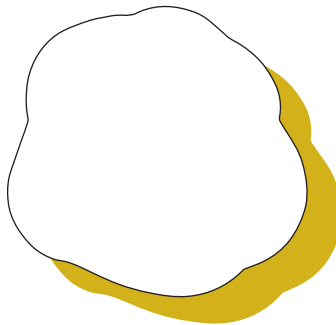
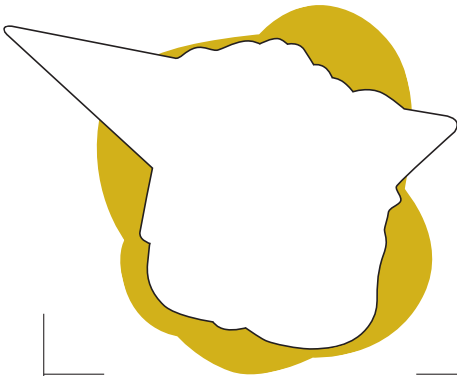

1313 / 1311	1313.1311.2	1314 / 1314	1314.1314.3	1314 / 1311	1314.1311.1
-------------	-------------	-------------	-------------	-------------	-------------

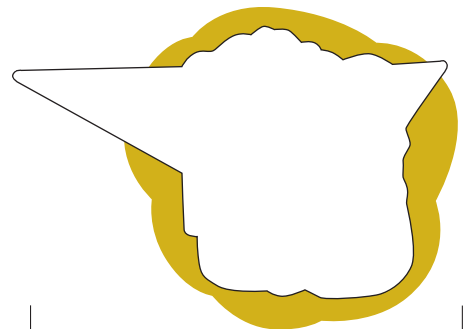
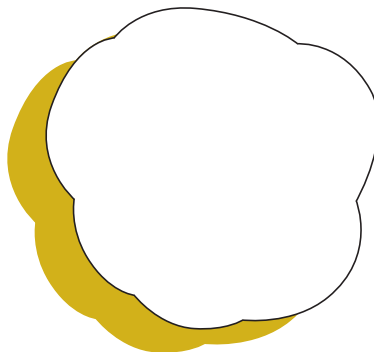
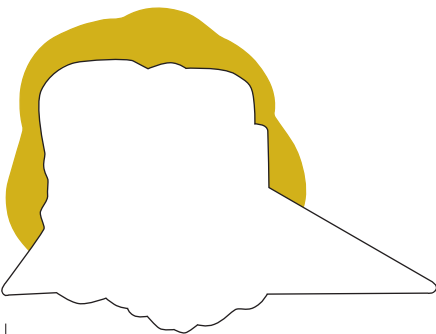

1314 / 1030	1314.1030.1	1314 / 1313	1314.1313.1	1314 / 1313	1314.1313.2
-------------	-------------	-------------	-------------	-------------	-------------

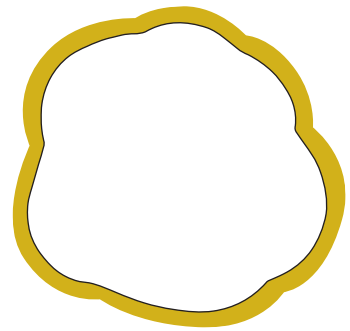
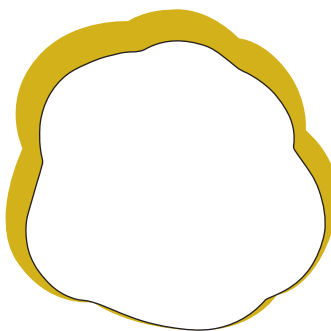
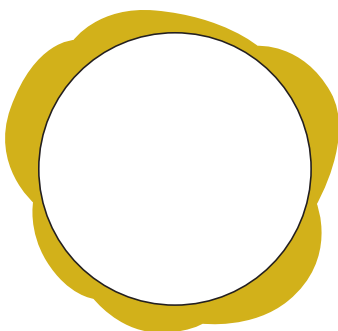

4) Unregelmässige, gerundete Figuren

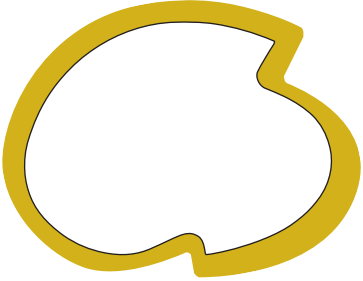
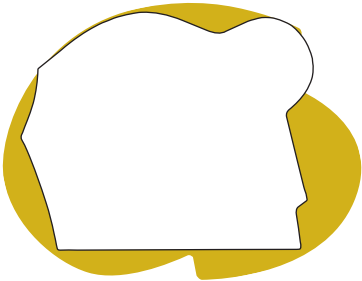
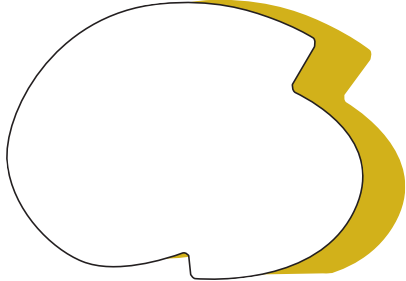
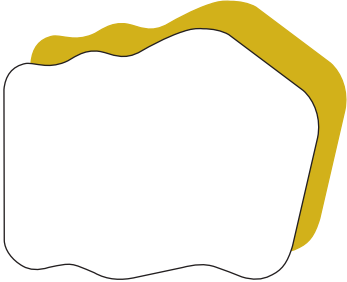
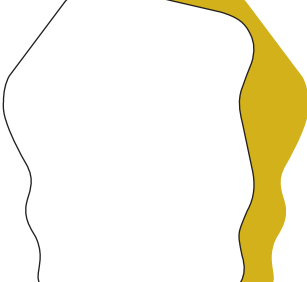
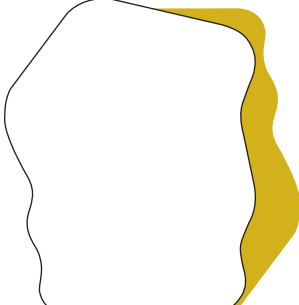
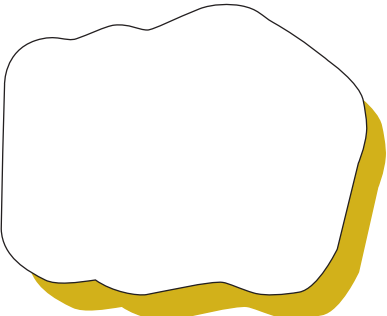
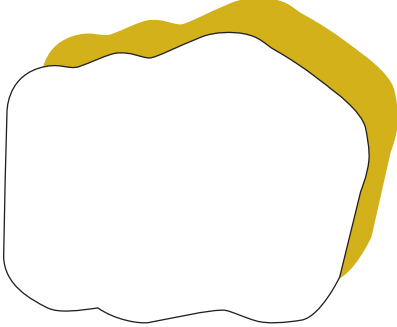
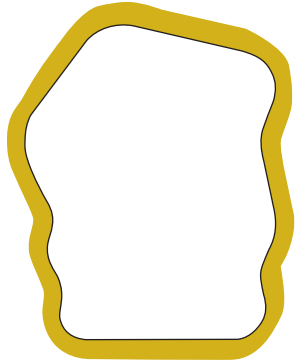
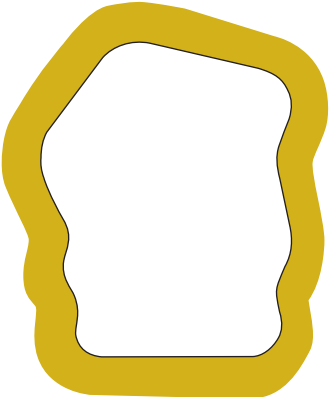
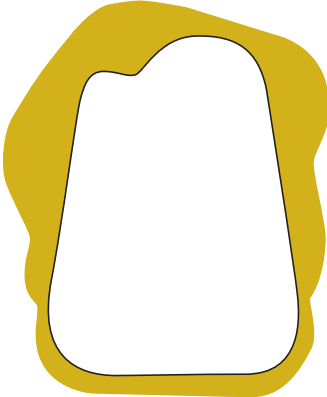
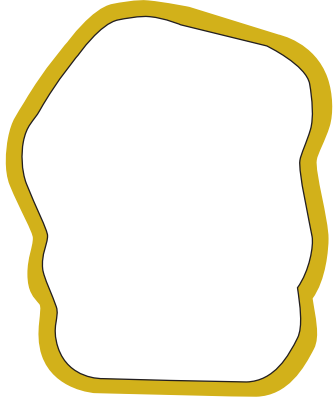
1347 / 1348	1347.1348.1	1347 / 1133	1347.1133.1	1347 / 1347	1347.1347.1
					
1152 / 1152	1152.1152.1	1152 / 1152	1152.1152.2	1152 / 1152	1152.1152.3
					
1153 / 1153	1153.1153.1	1153 / 1153	1153.1153.2	1153 / 1152	1153.1152.1
					
1154 / 1152	1154.1152.1	1154 / 1193	1154.1193.1	1154 / 1153	1154.1153.1
					

4) Unregelmässige, gerundete Figuren



4) Unregelmässige, gerundete Figuren

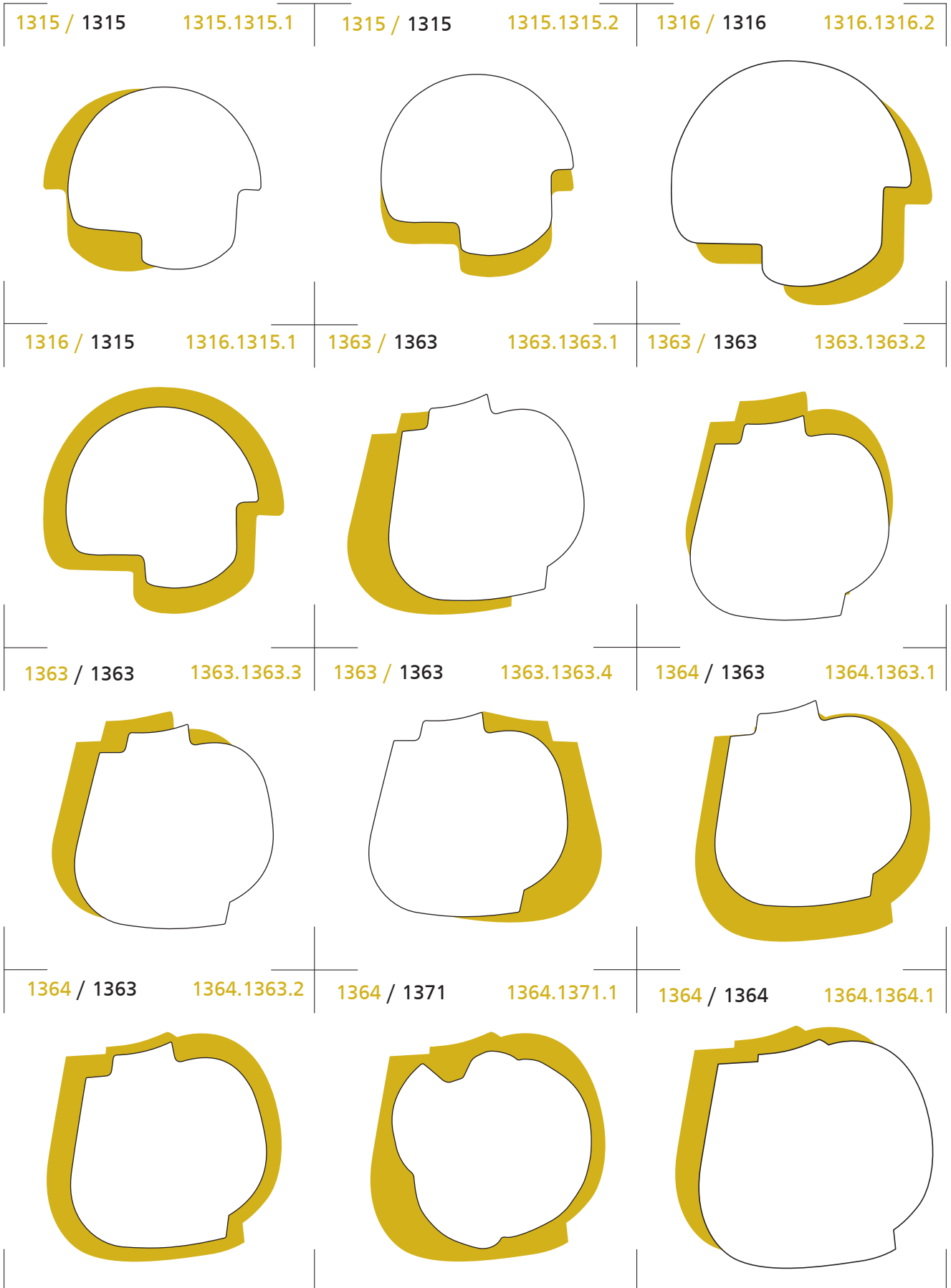

4) Unregelmässige, gerundete Figuren

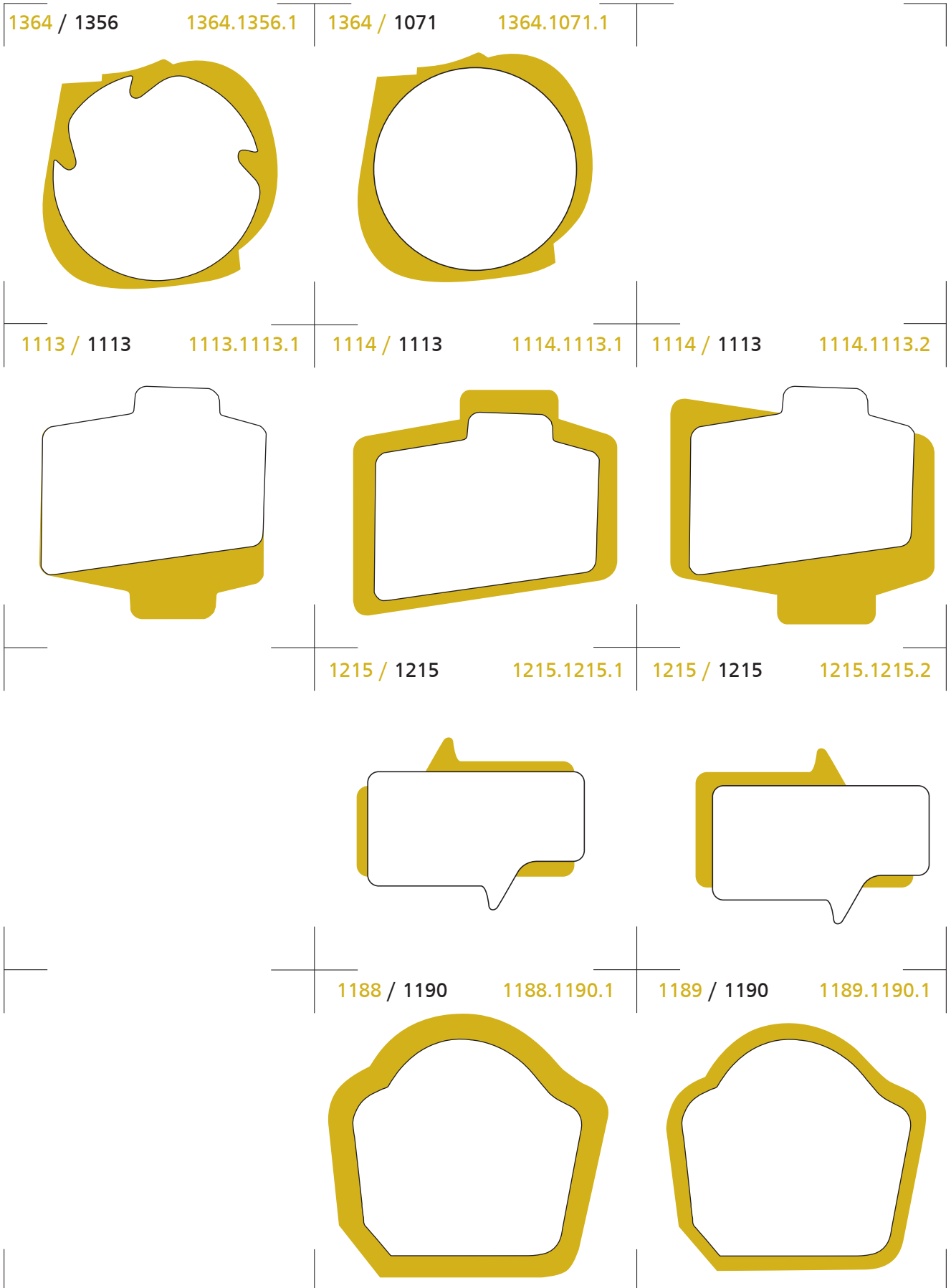

4) Unregelmässige, gerundete Figuren

1205 / 1205 1205.1205.1 1205 / 1205 1205.1205.2 1206 / 1205 1206.1205.3

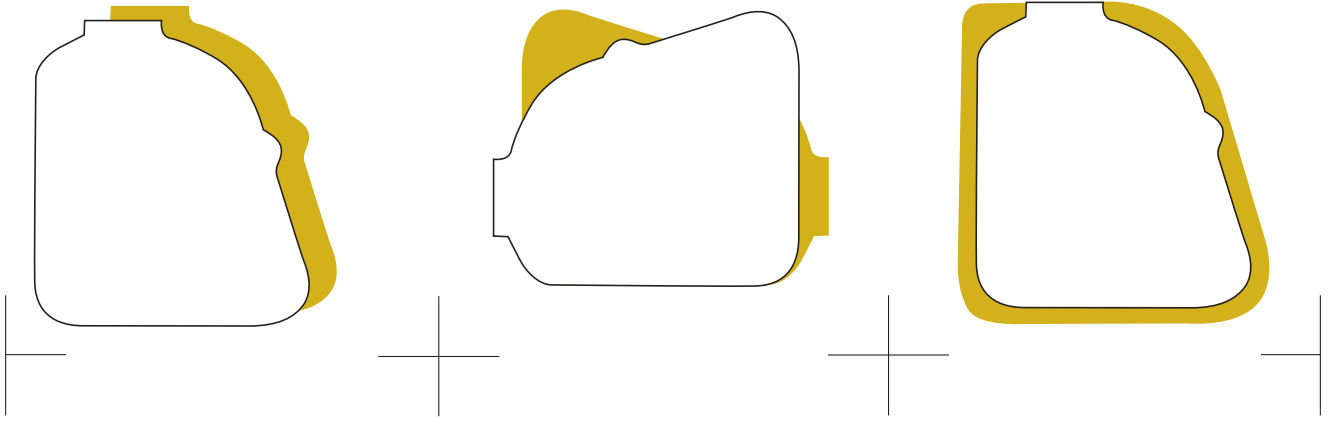

4) Unregelmässige, gerundete Figuren

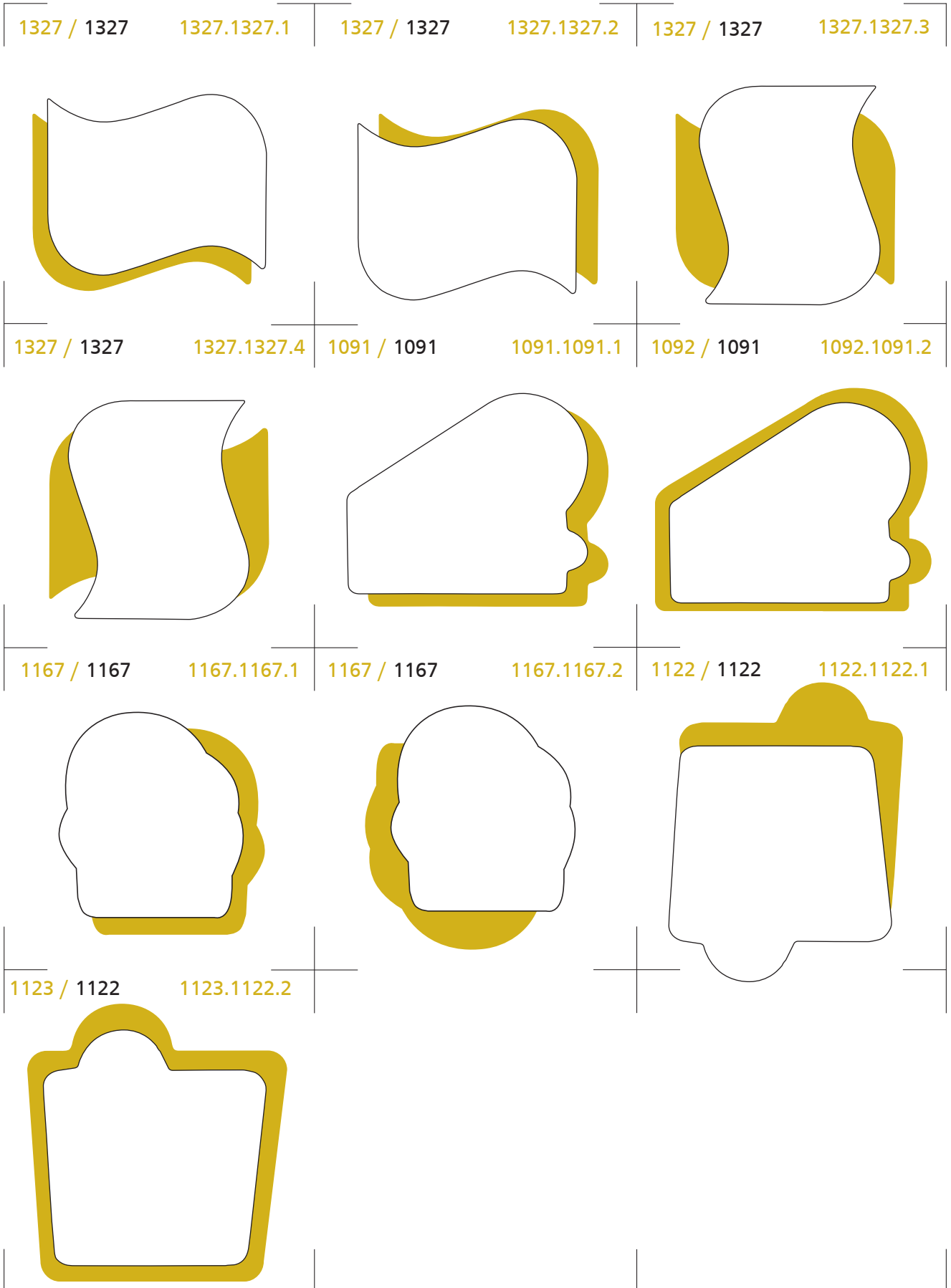

4) Unregelmässige, gerundete Figuren

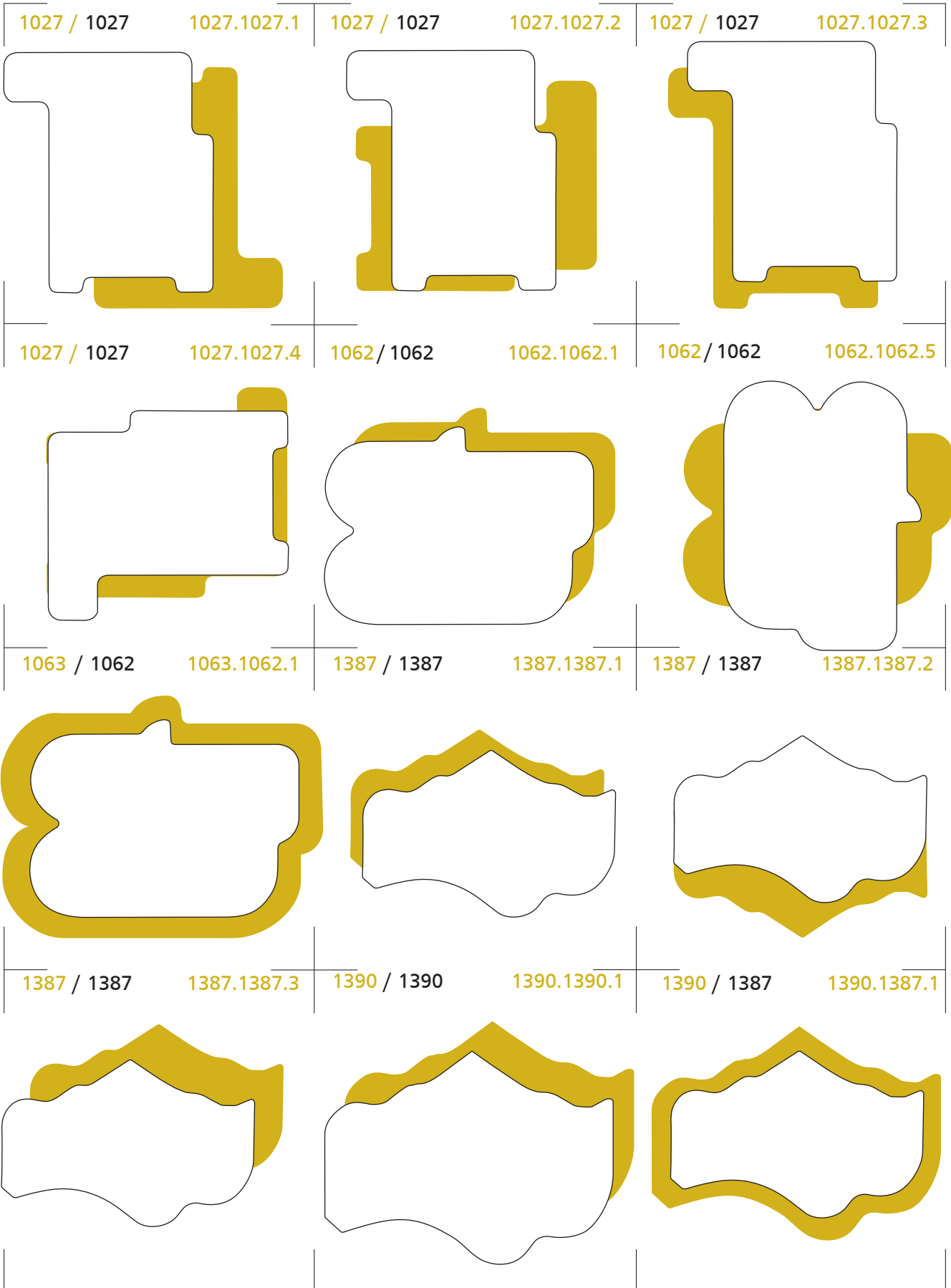

4) Unregelmässige, gerundete Figuren

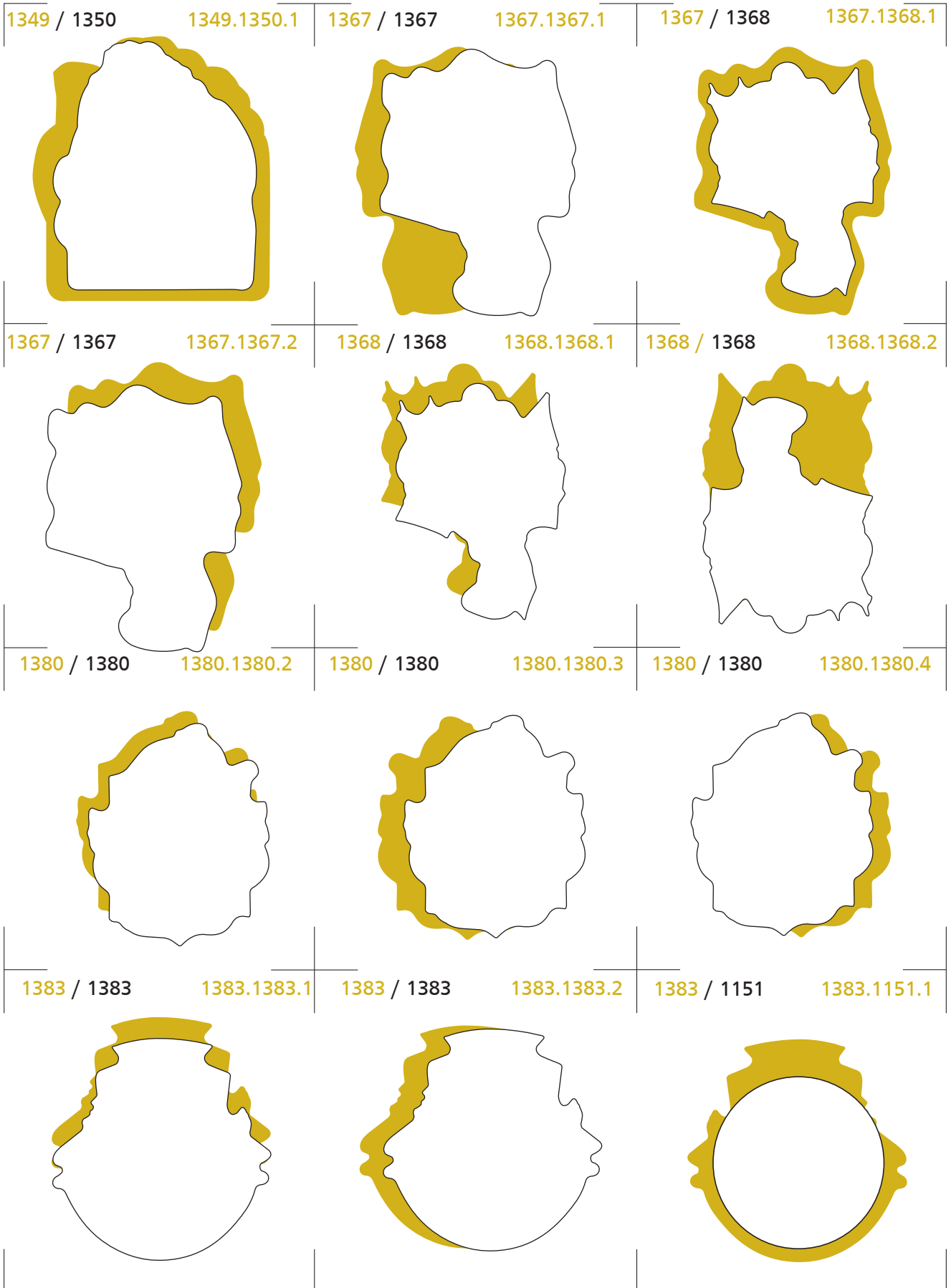

4) Unregelmässige, gerundete Figuren

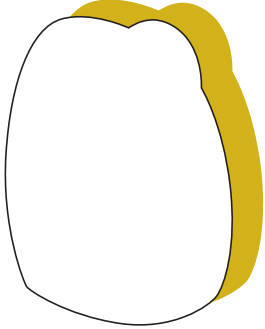
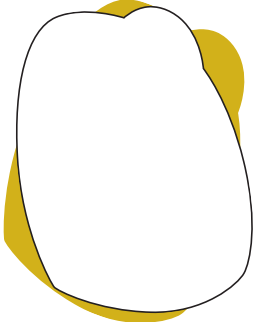
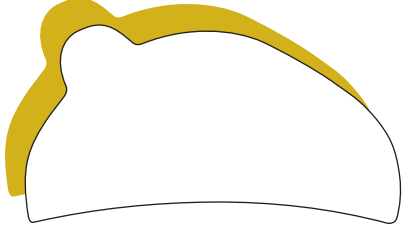
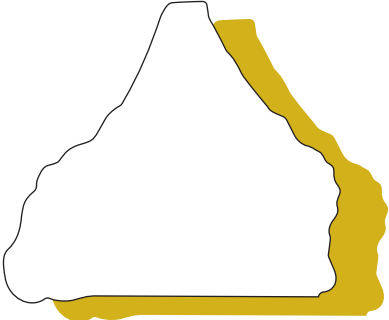
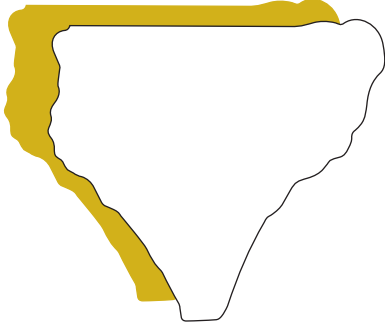
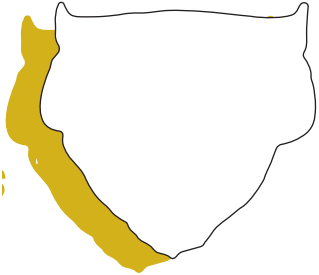
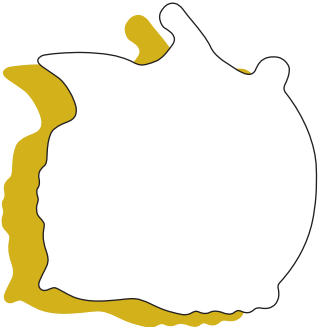
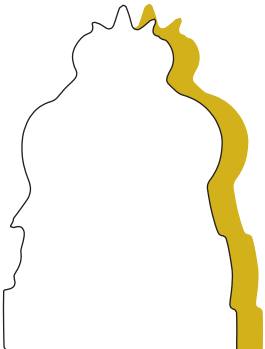
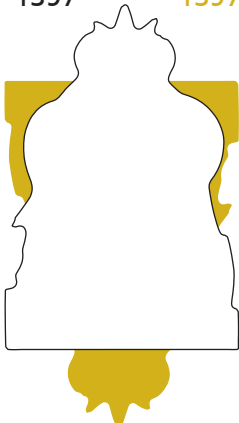
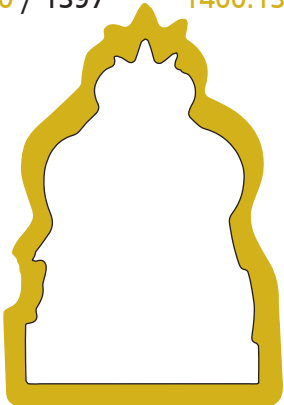
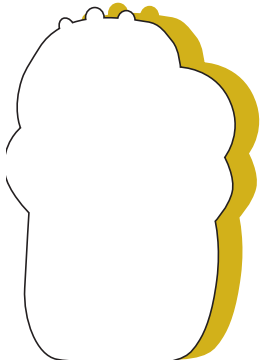
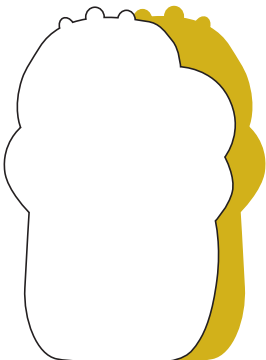
1127 / 1127	1127.1127.1	1127 / 1127	1127.1127.2	1365 / 1365	1365.1365.1
					
1357 / 1357	1357.1357.1	1357 / 1357	1357.1357.3	1370 / 1370	1370.1370.1
					
1391 / 1391	1391.1391.1	1397 / 1397	1397.1397.1	1397 / 1397	1397.1397.2
					
1400 / 1397	1400.1397.1	1166 / 1166	1166.1166.1	1166 / 1166	1166.1166.2
					



Plaketten

Übersicht Doppelschnitte:

5) Unregelmässige, eckige Figuren

5) Unregelmässige, eckige Figuren

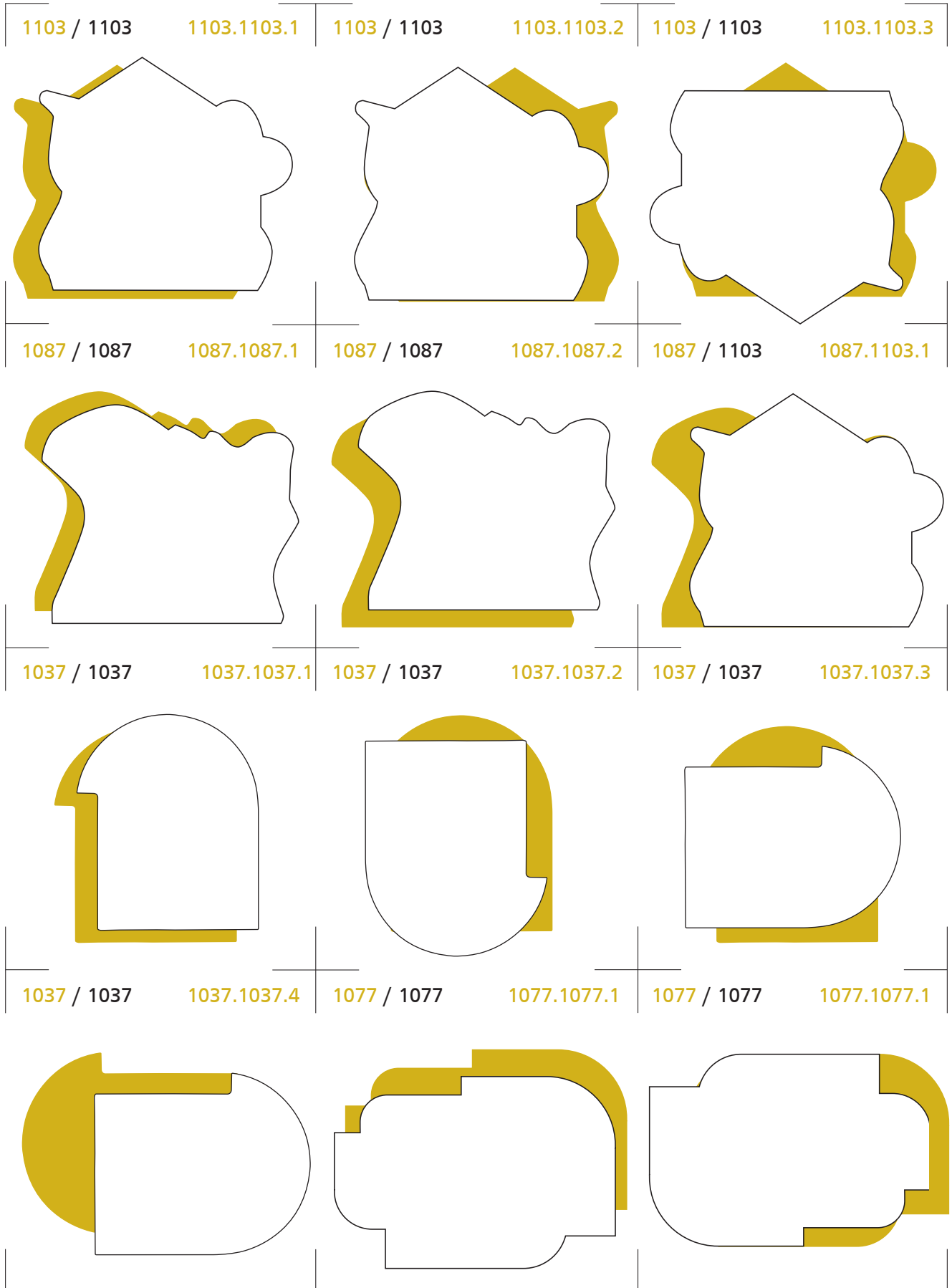

5) Unregelmässige, eckige Figuren

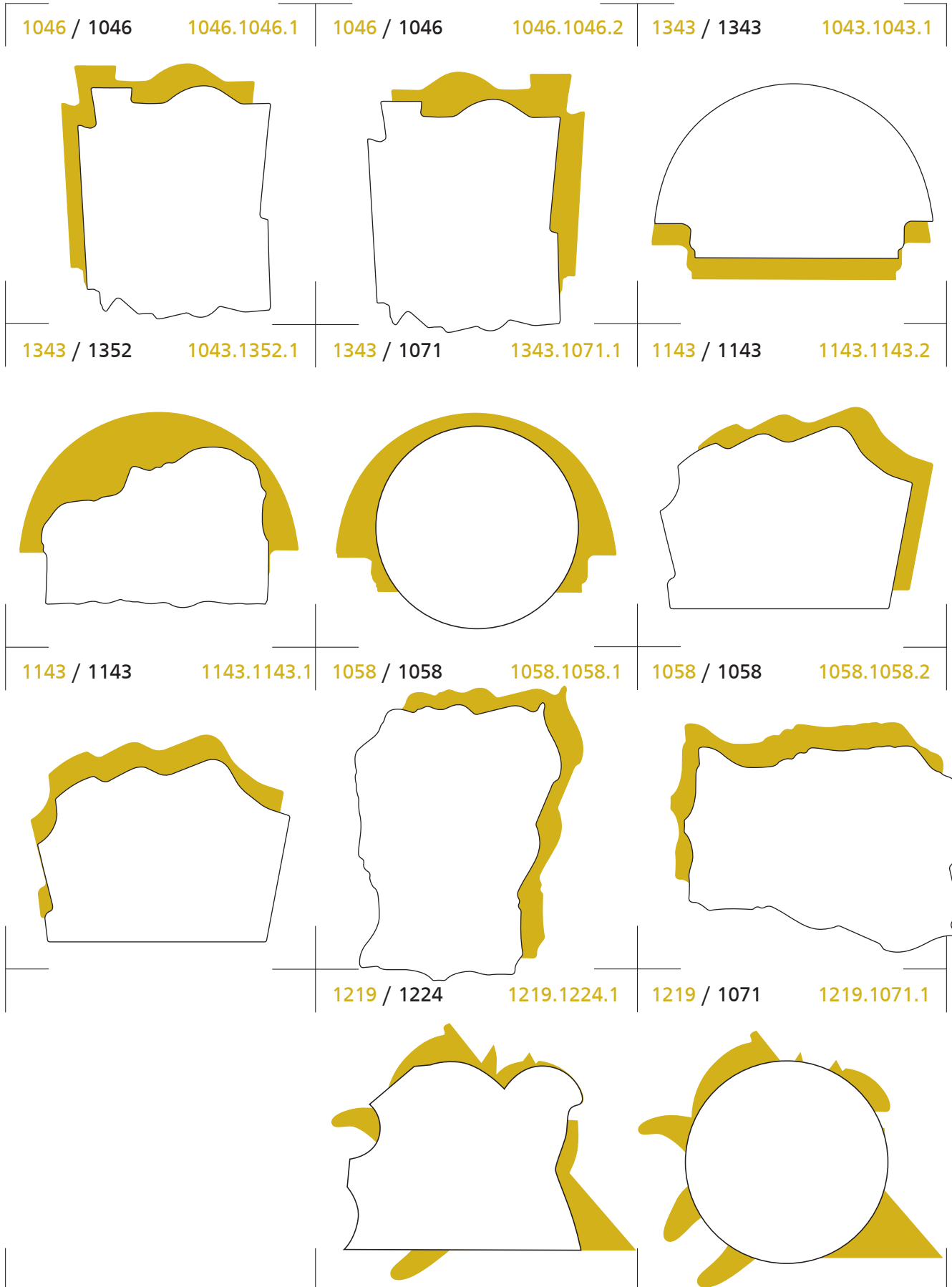

5) Unregelmässige, eckige Figuren

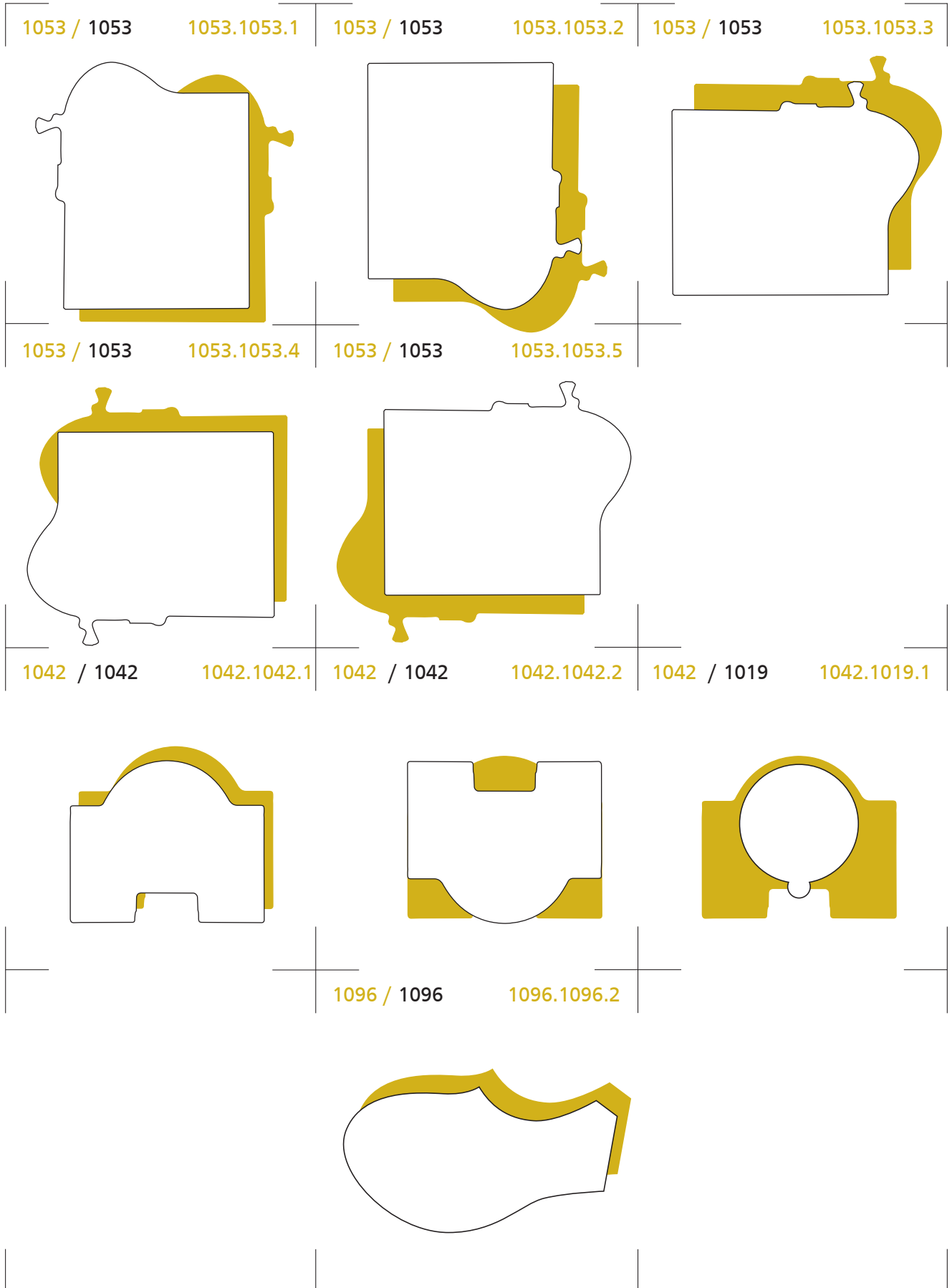

5) Unregelmässige, eckige Figuren

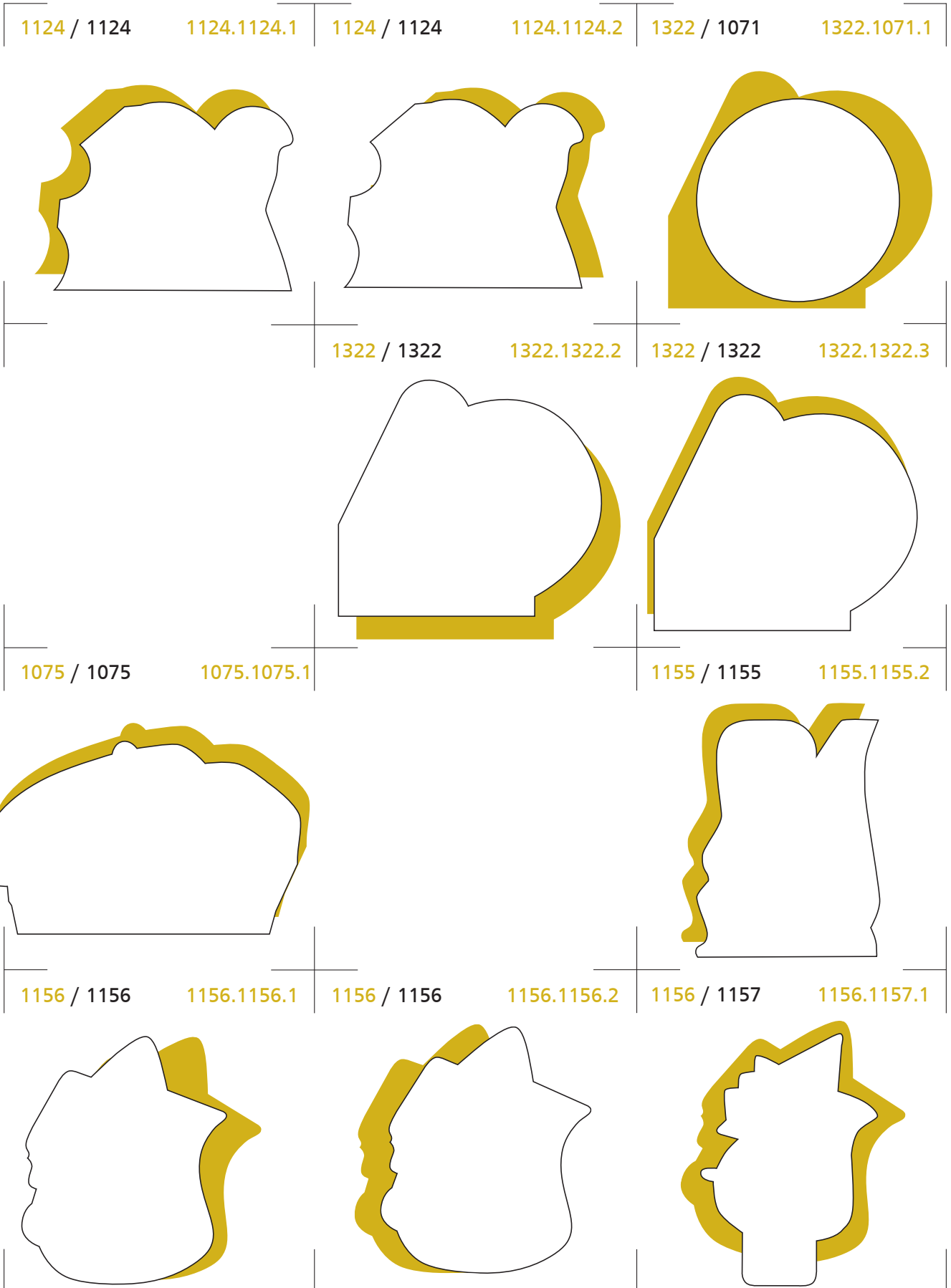

5) Unregelmässige, eckige Figuren

1168 / 1168	1168.1168.1	1168 / 1168	1168.1168.2	1168 / 1168	1168.1168.3
-------------	-------------	-------------	-------------	-------------	-------------

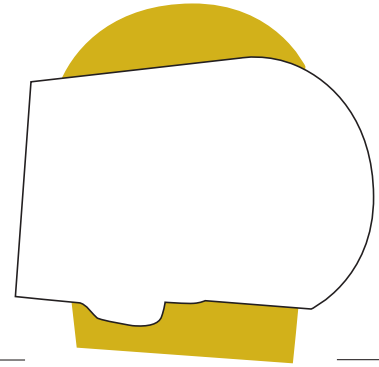
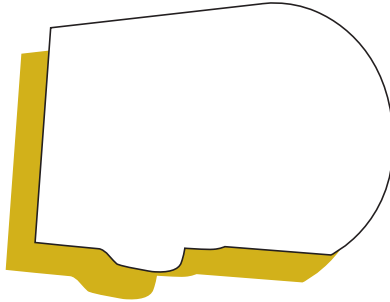
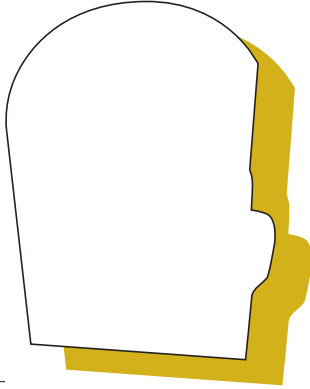

1170 / 1170	1170.1170.1	1170 / 1170	1170.1170.2	1187 / 1187	1187.1187.1
-------------	-------------	-------------	-------------	-------------	-------------

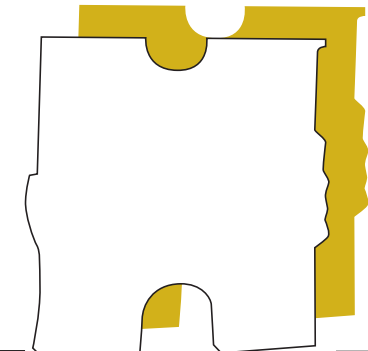
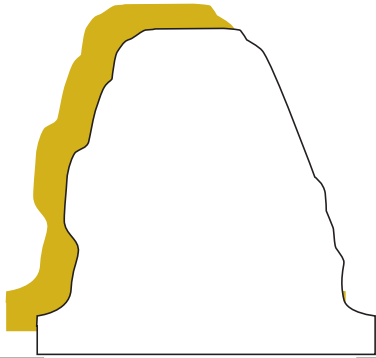

1179 / 1179	1179.1179.1	1179 / 1179	1179.1179.2	1179 / 1179	1179.1179.3
-------------	-------------	-------------	-------------	-------------	-------------

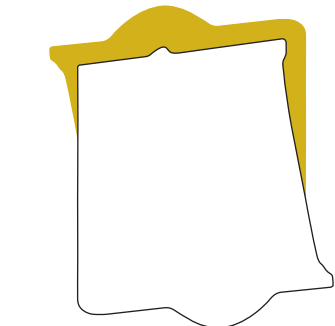
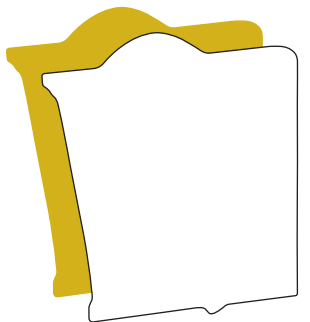

1145 / 1145	1145.1145.1
-------------	-------------

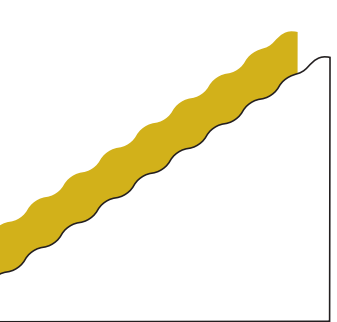

5) Unregelmässige, eckige Figuren

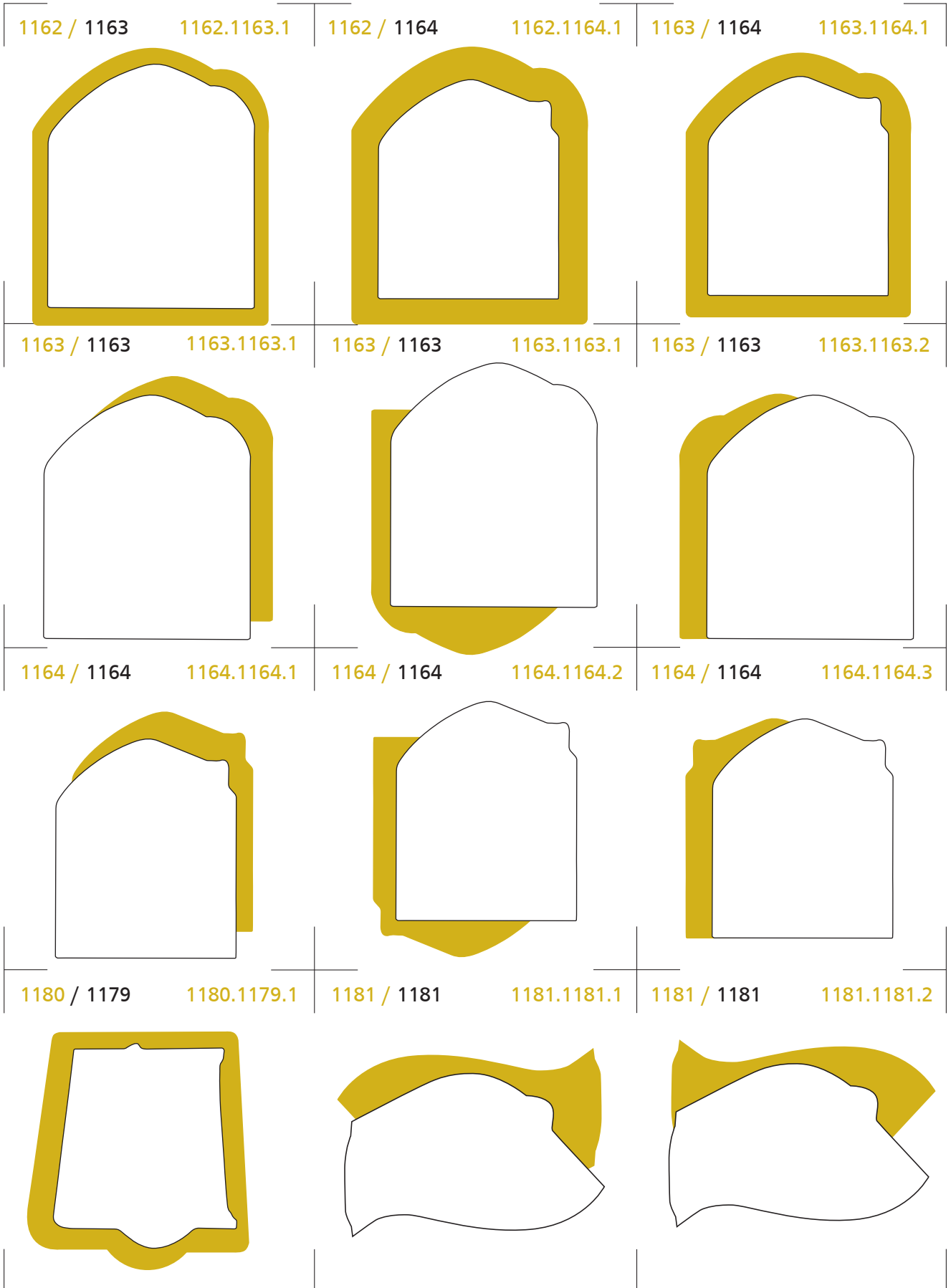

5) Unregelmässige, eckige Figuren

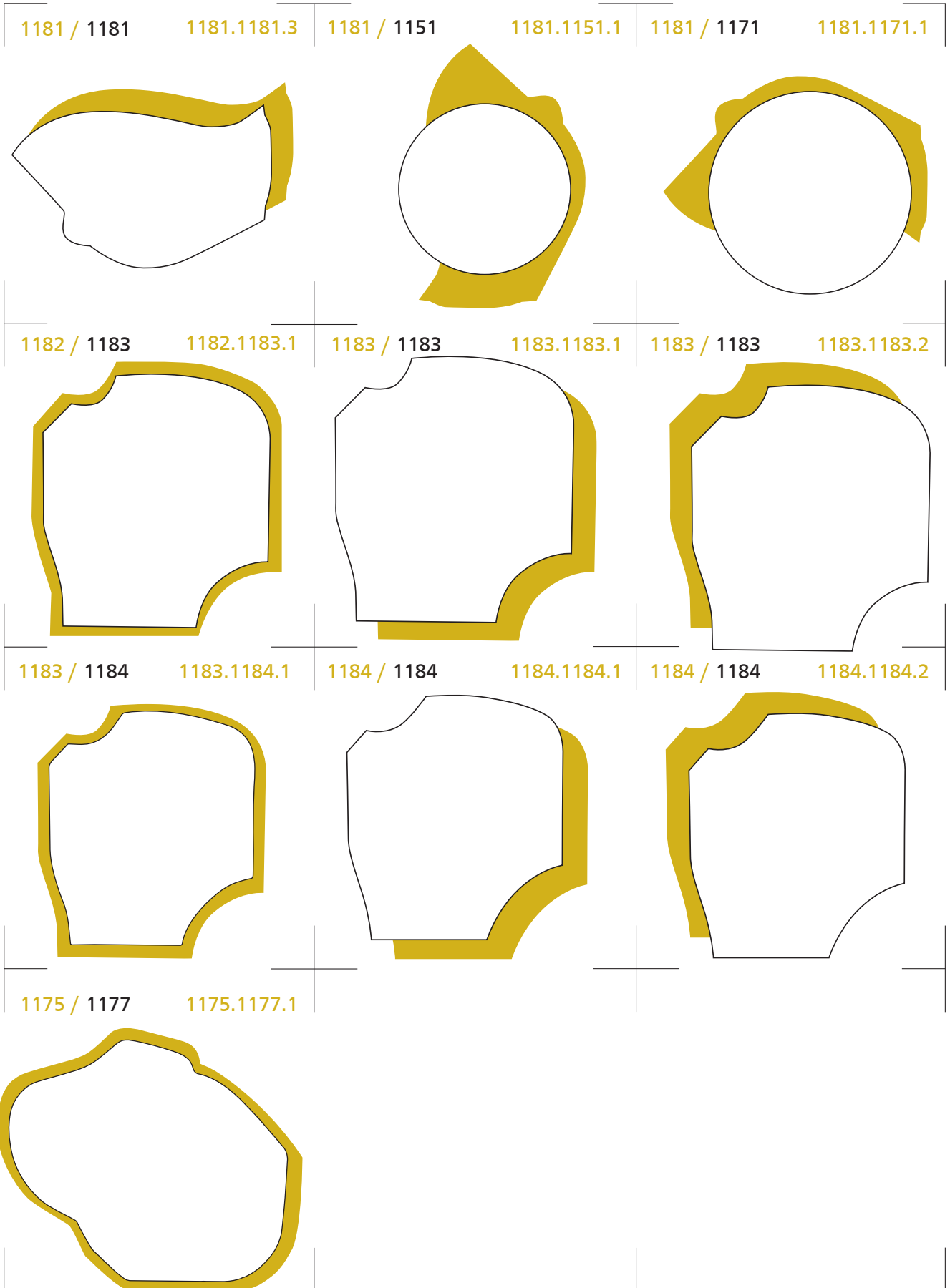

5) Unregelmässige, eckige Figuren

1176 / 1176 1176.1176.1 1176 / 1176 1176.1176.2 1176 / 1176 1176.1176.3

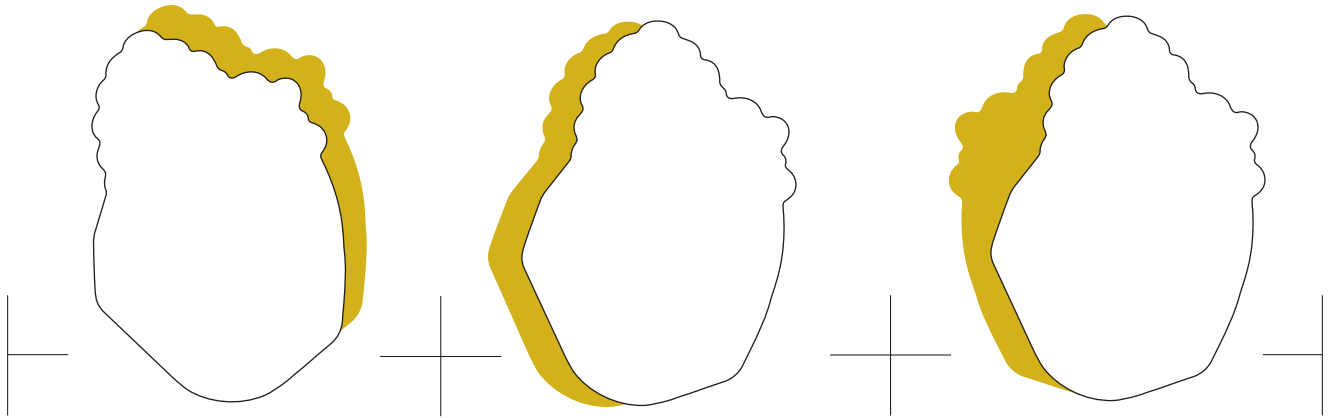

1177 / 1177 1177.1177.1 1177 / 1177 1177.1177.2

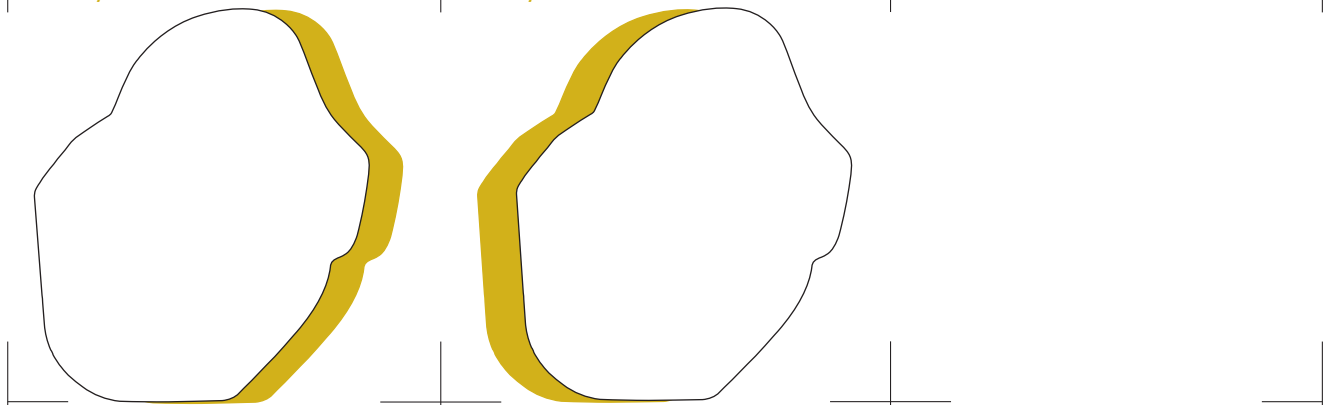

1192 / 1192 1192.1192.1 1192 / 1192 1192.1192.2 1192 / 1192 1192.1192.3

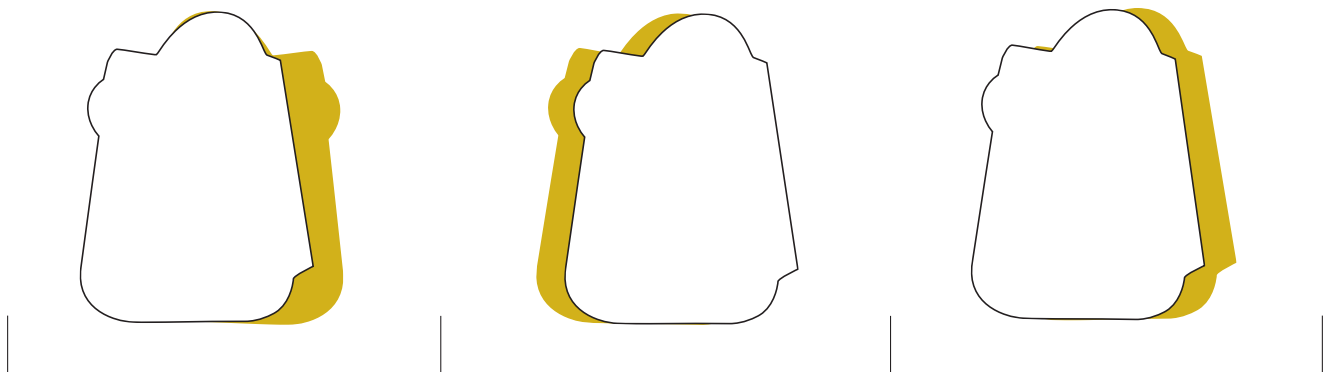

5) Unregelmässige, eckige Figuren

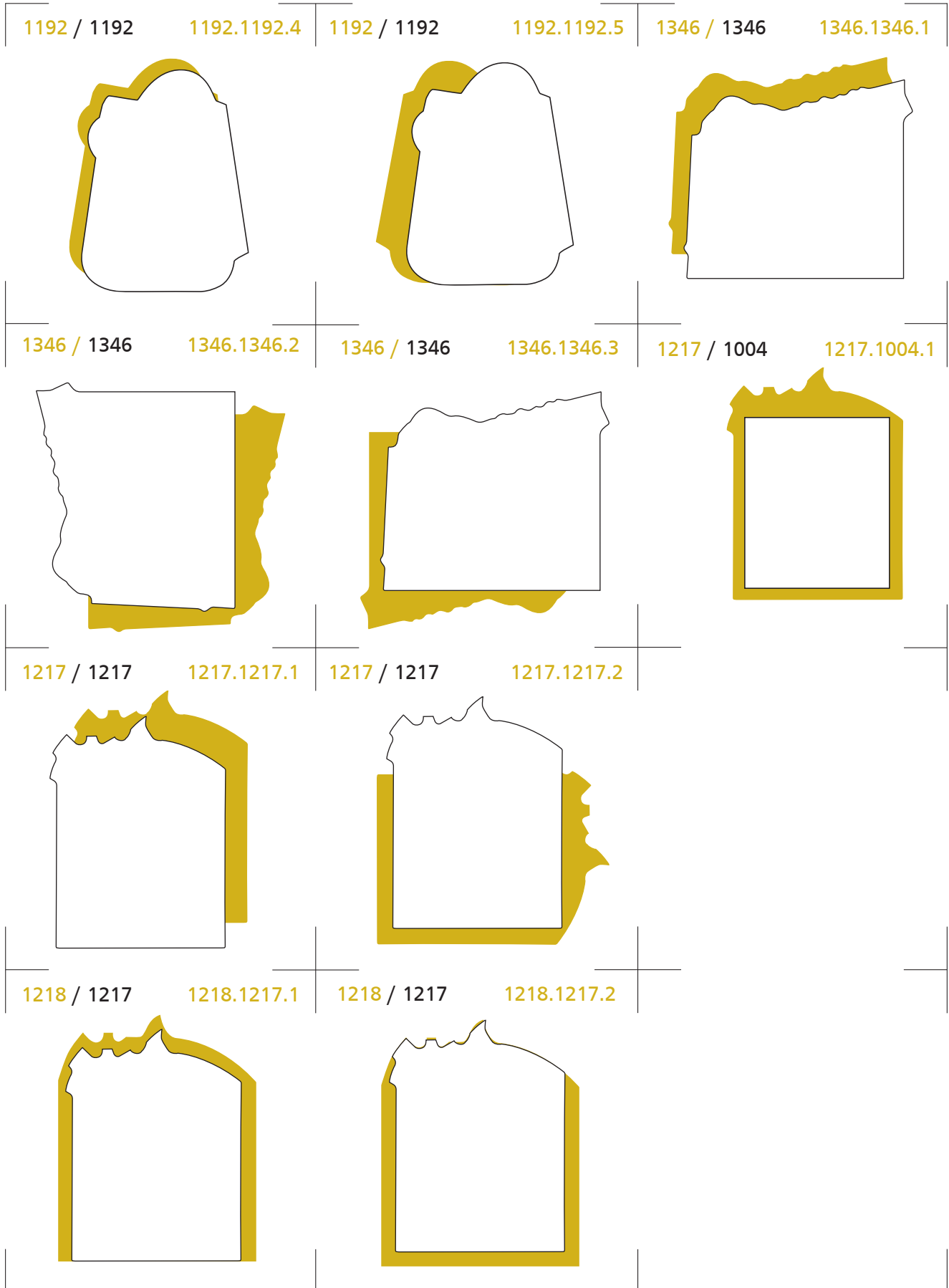

5) Unregelmässige, eckige Figuren

1381 / 1381 1381.1381.1 1381 / 1381 1381.1381.2 1381 / 1380 1381.1380.1

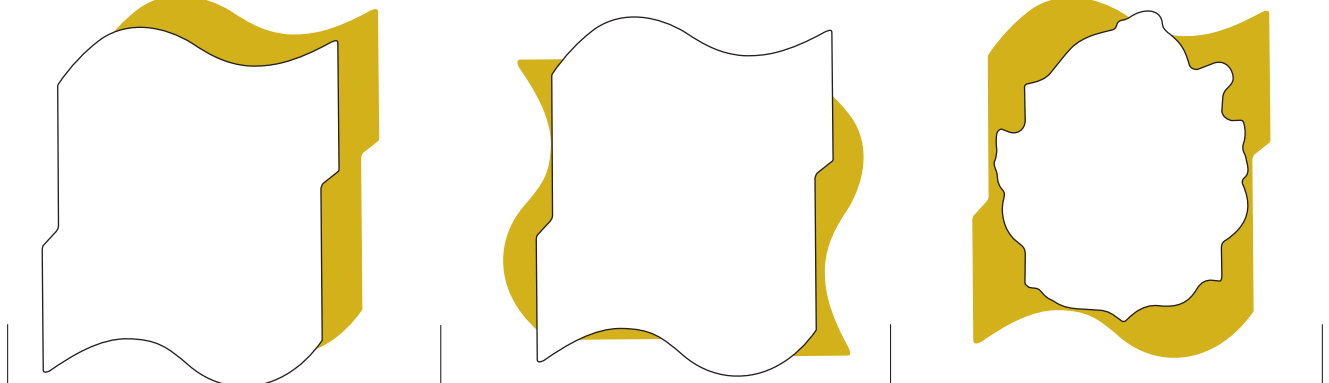

1300 / 1301 1300.1301.1 1301 / 1301 1301.1301.1 1307 / 1311 1307.1311.1

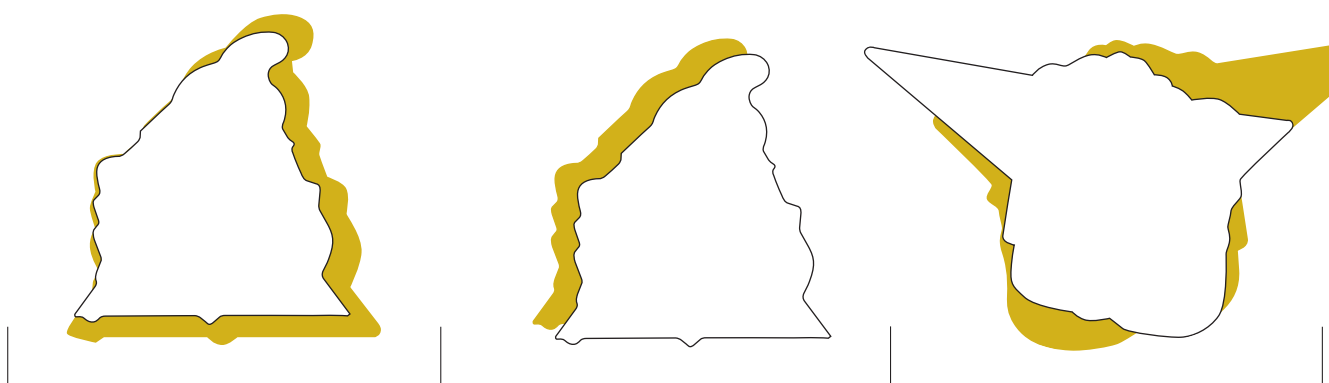

1307 / 1311 1307.1311.1 1329 / 1329 1329.1329.1 1329 / 1329 1329.1329.2

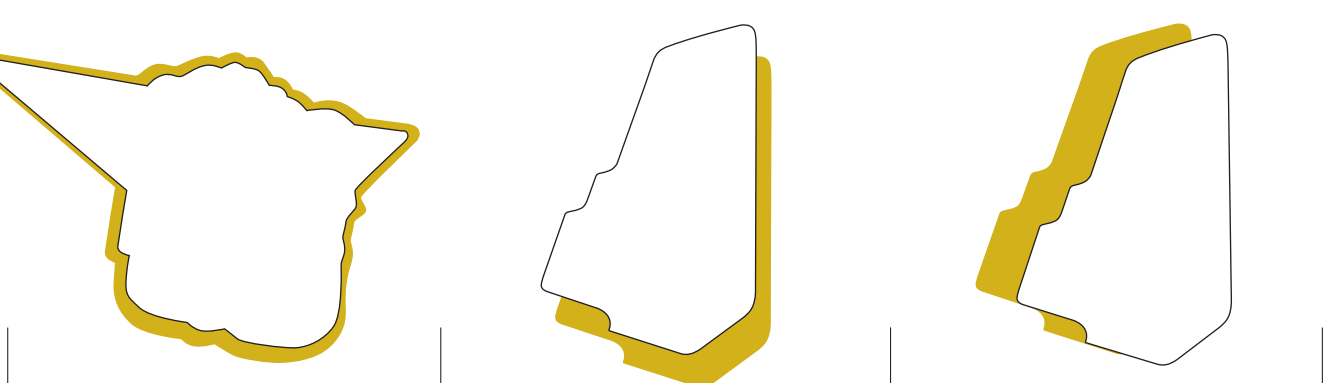

1329 / 1329 1329.1329.3 1329 / 1329 1329.1329.4 1330 / 1329 1330.1329.1

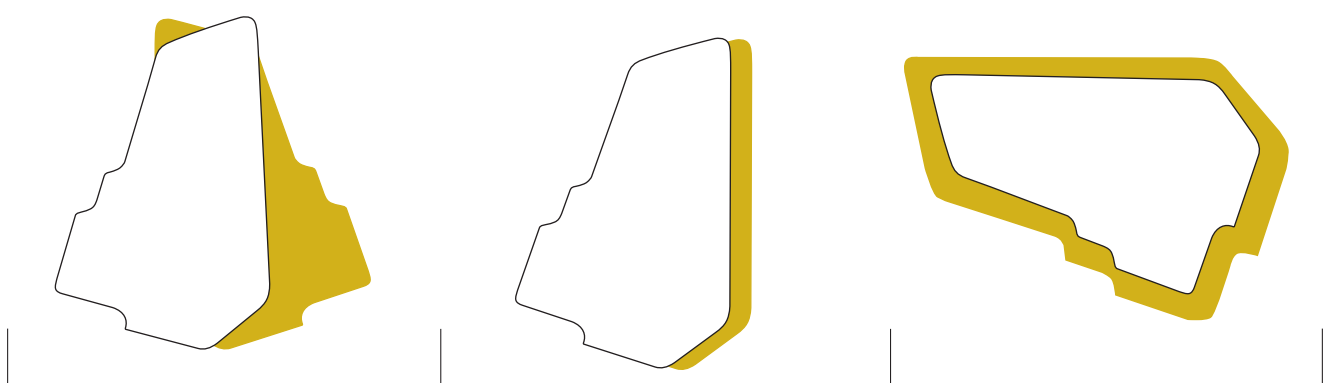

5) Unregelmässige, eckige Figuren



5) Unregelmässige, eckige Figuren

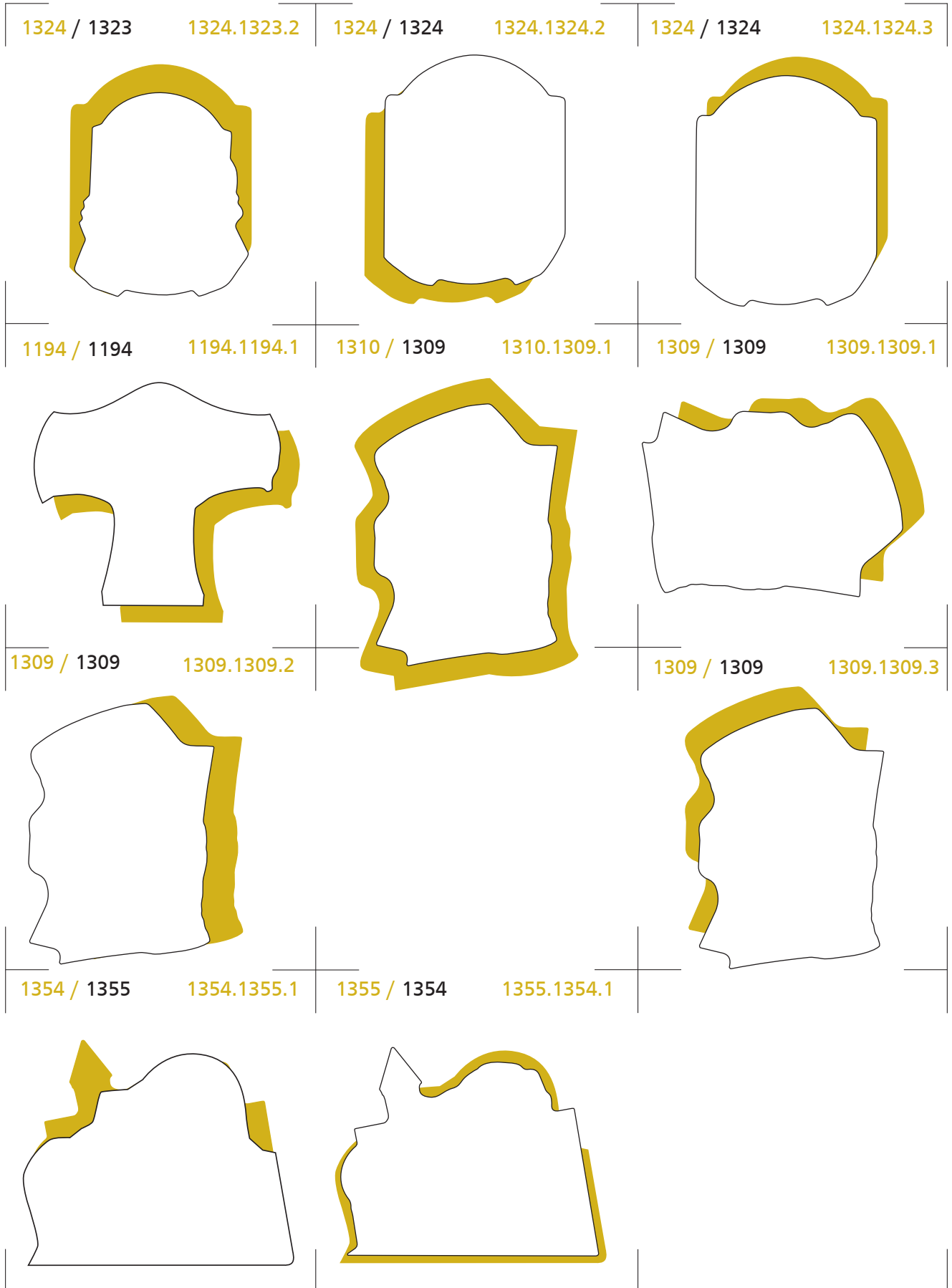

5) Unregelmässige, eckige Figuren

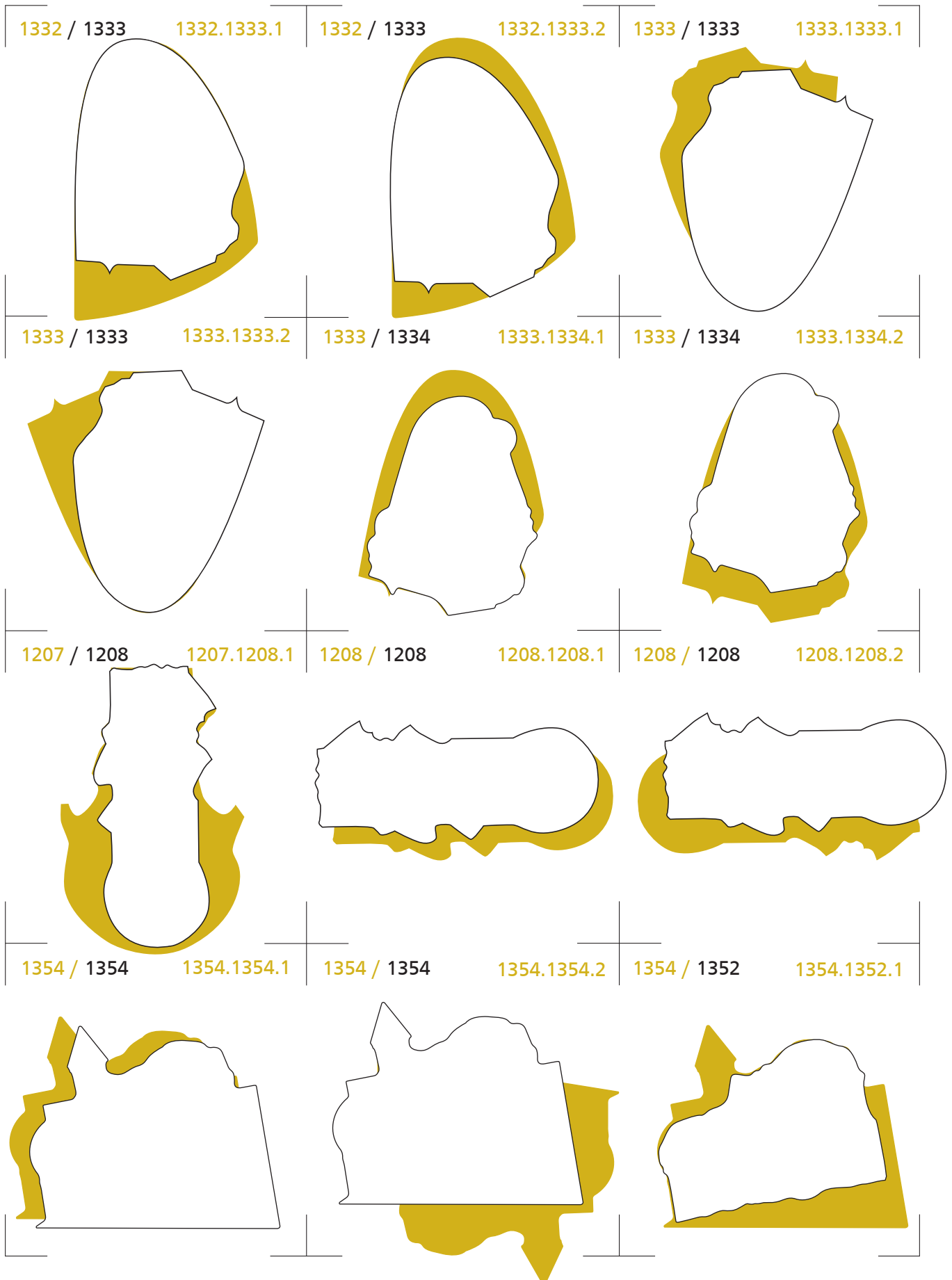



Plaketten

Übersicht Doppelschnitte:

6) Erkennbare Figuren, Herzen, Wappen usw.

6) Erkennbare Figuren

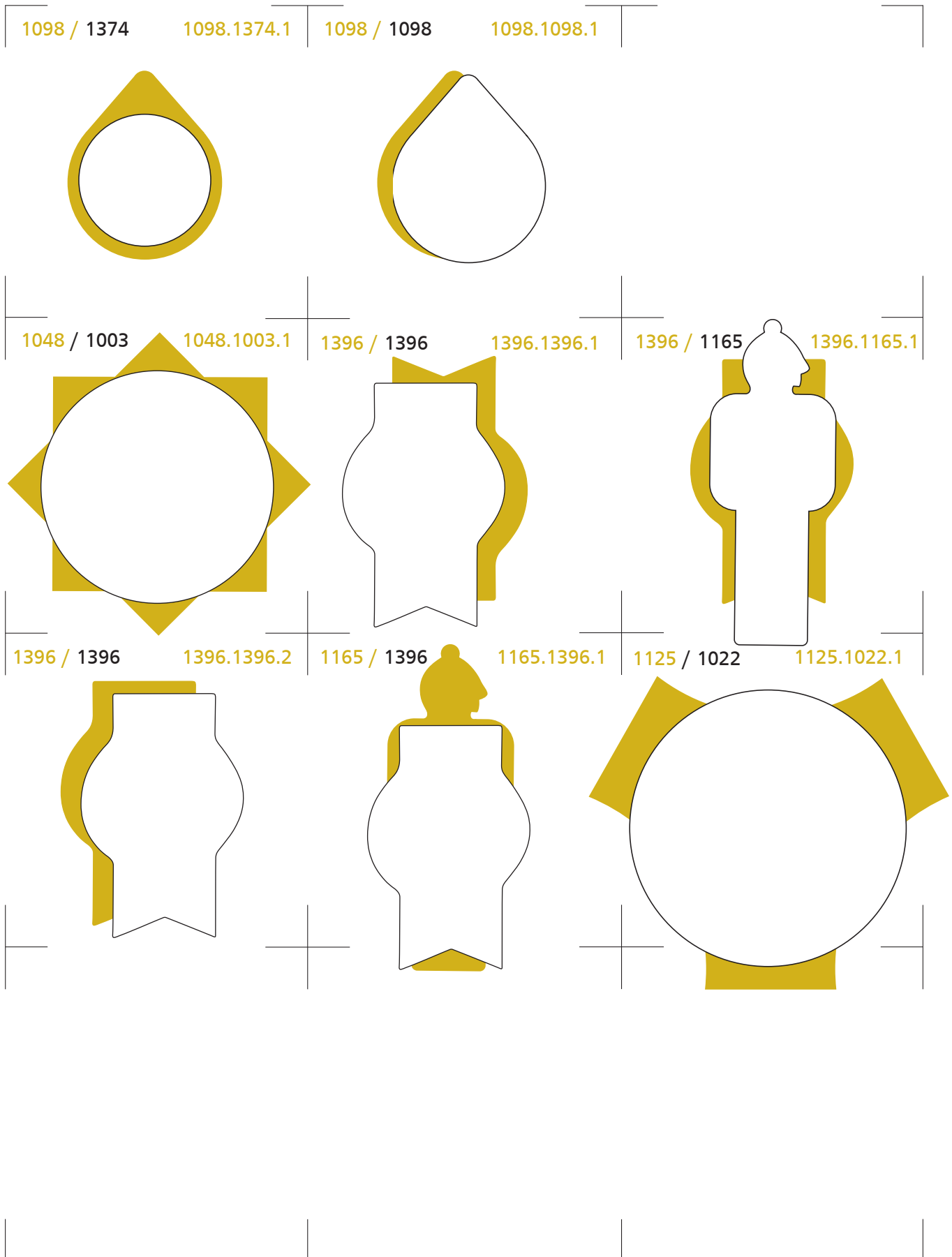

6) Erkennbare Figuren - Herzen

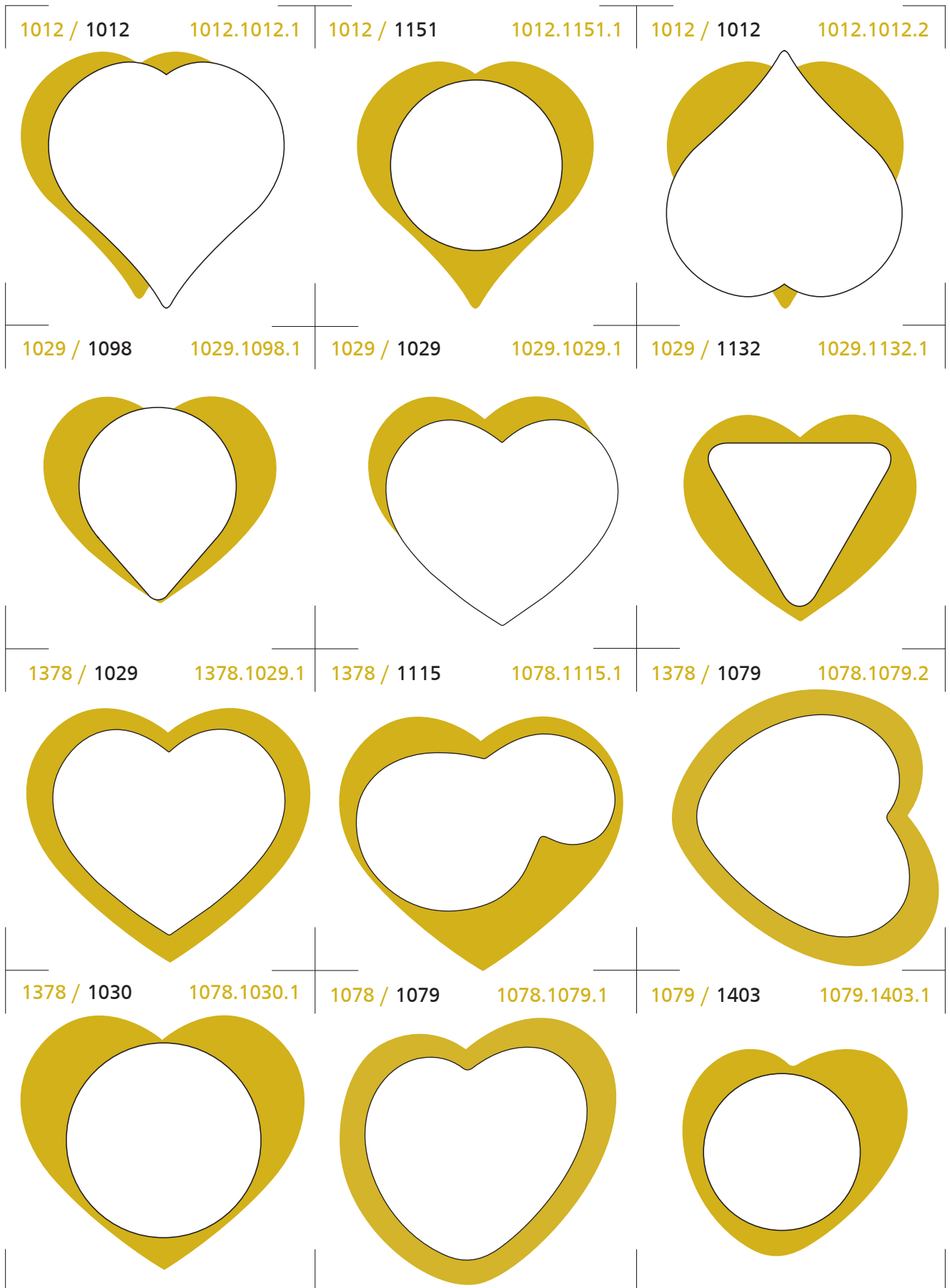

6) Erkennbare Figuren - Wappen und ähnliche

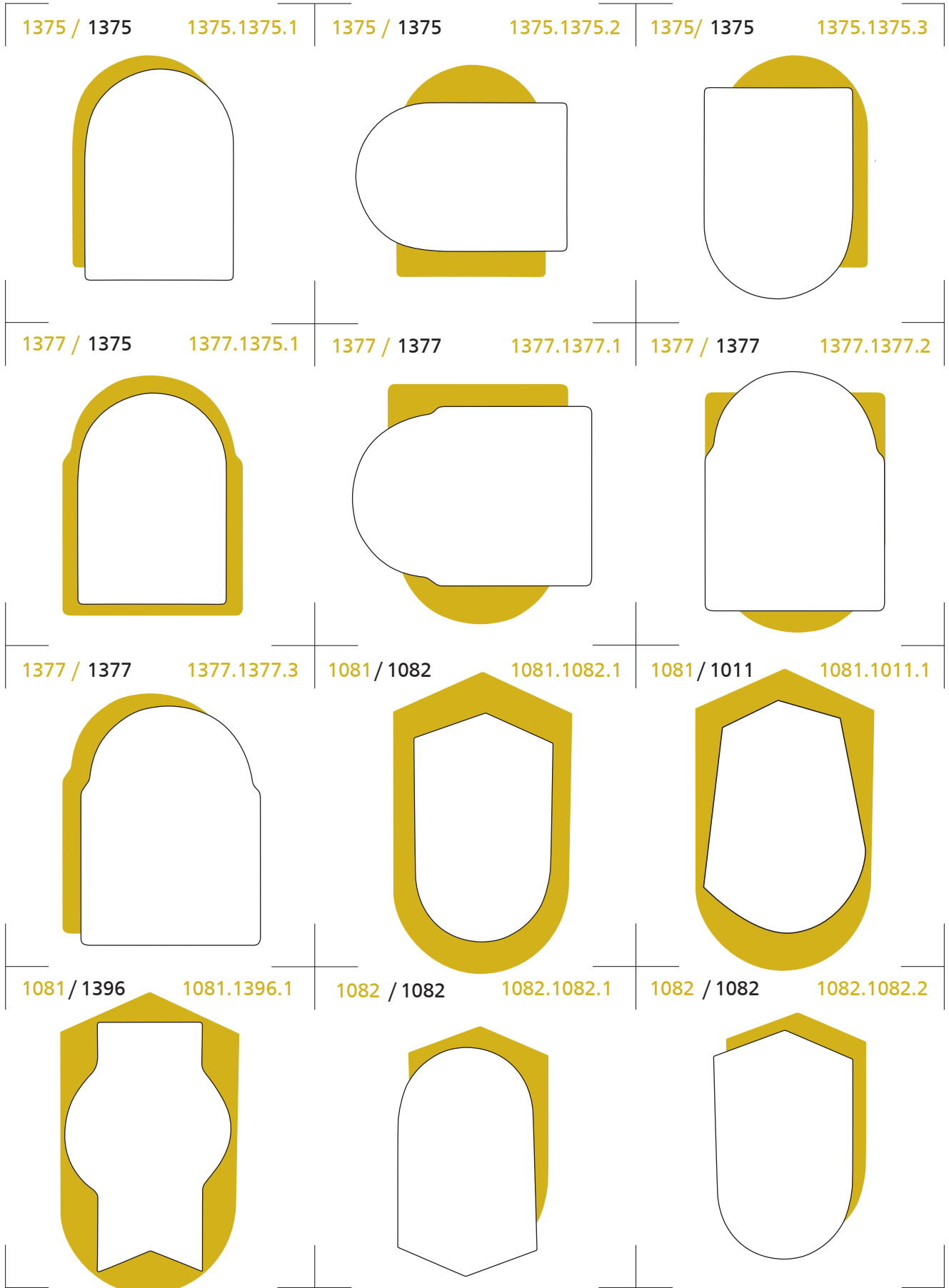

6) Erkennbare Figuren □ Wappen und ähnliche

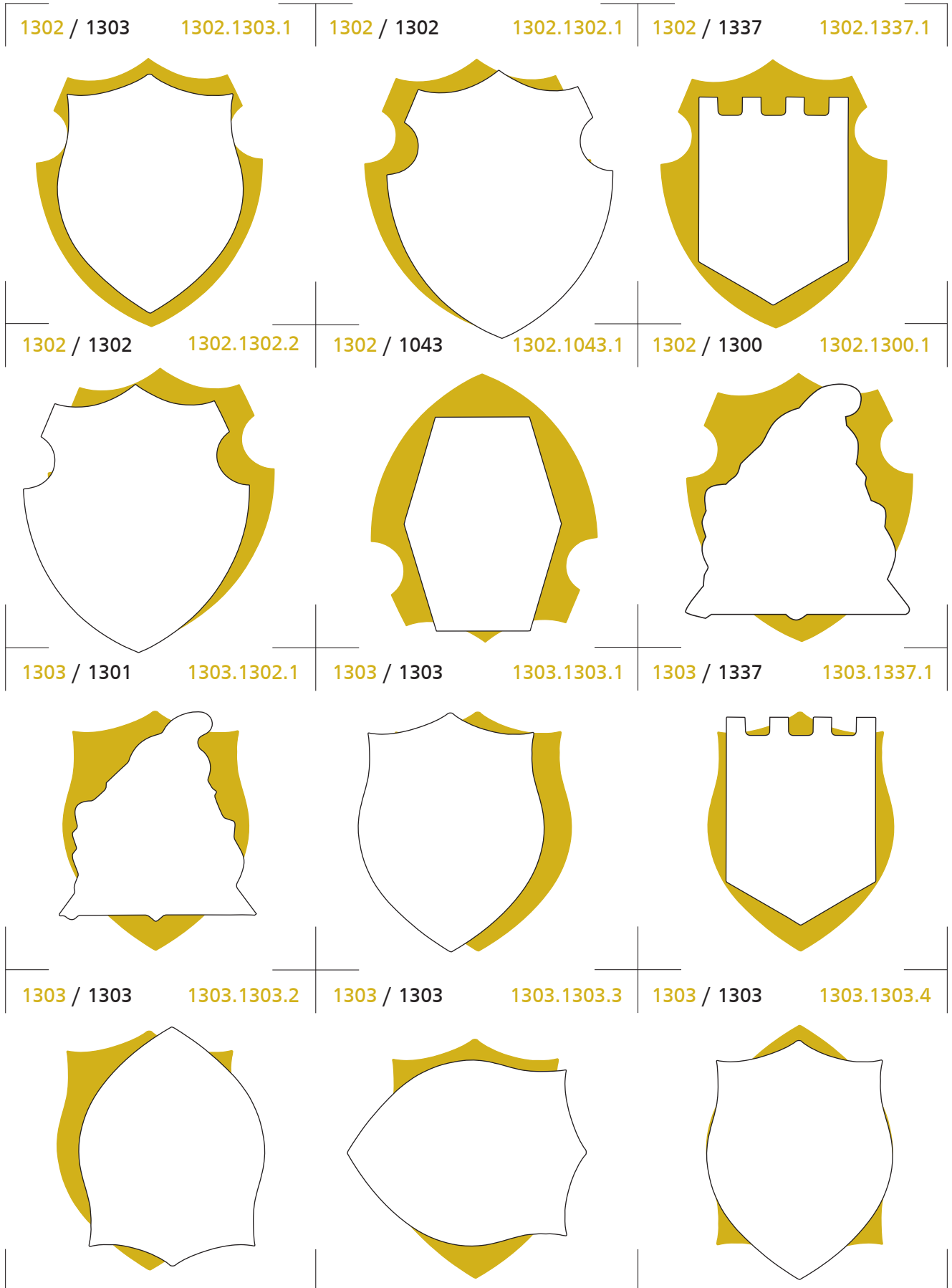

6) Erkennbare Figuren - Wappen und ähnliche

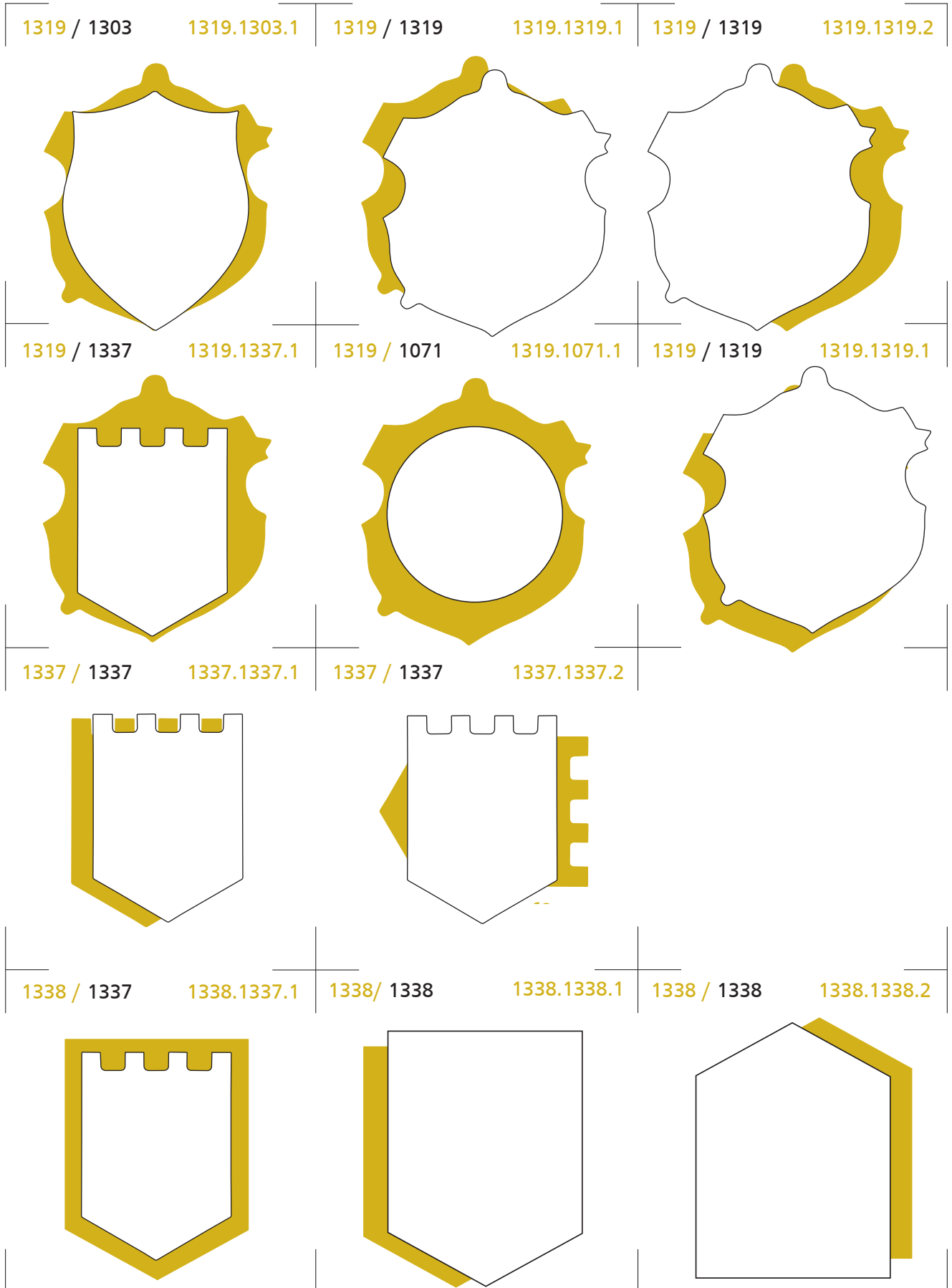

6) Erkennbare Figuren

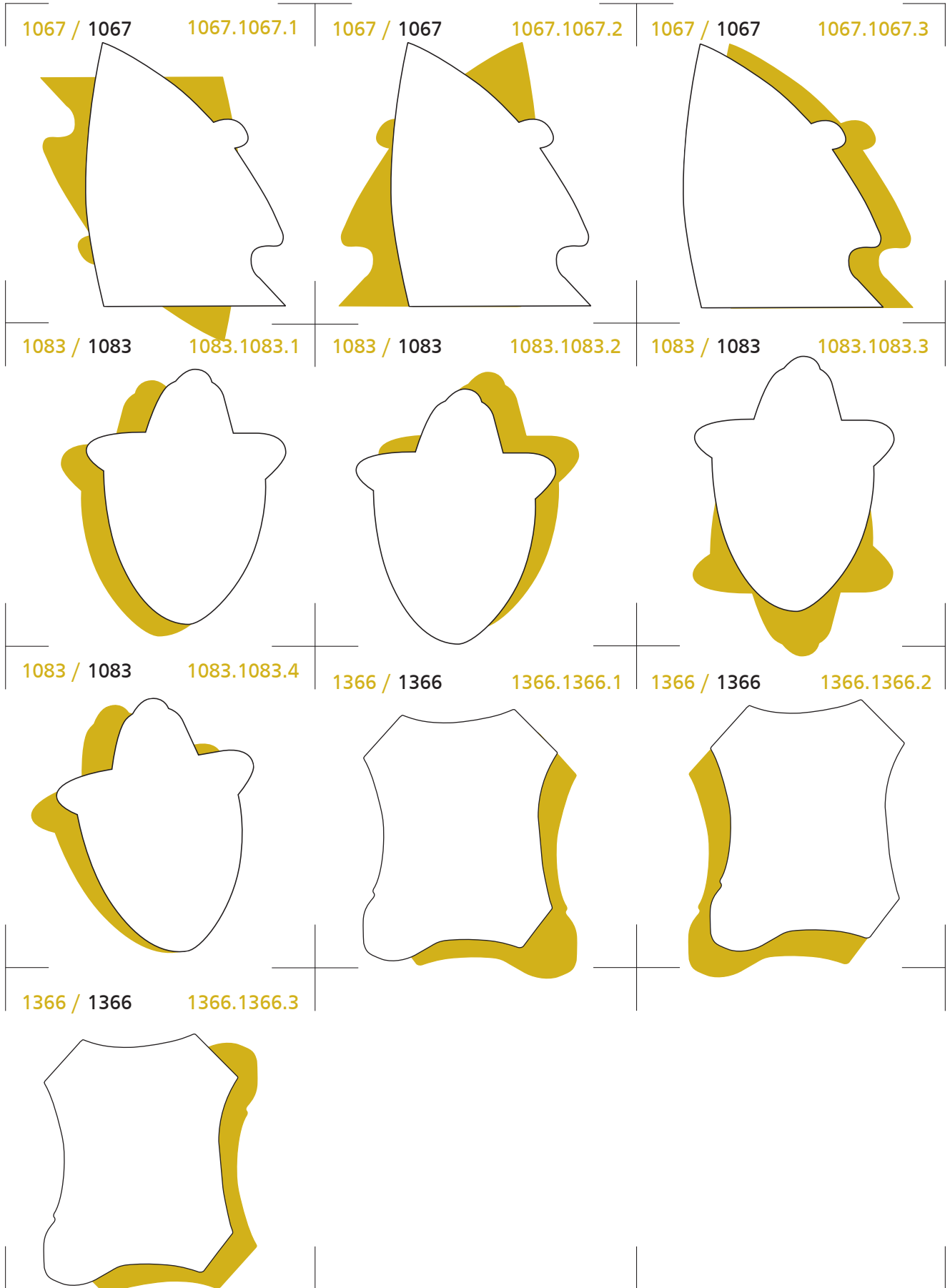



Pins

Übersicht Einzelschnitte:
Verschiedene Figuren

7) Verschiedene Figuren

1072 Ø 8 mm 1099 Ø 12 mm 1073 Ø 13 mm

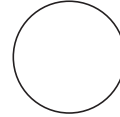
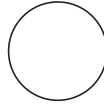

1203 Ø 10 mm 1149 Ø 19 mm 1039 Ø 21 mm

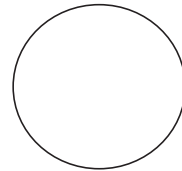
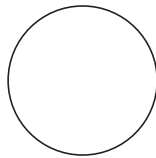

1150 Ø 23 mm 1374 Ø 25 mm 1120 Ø 15 mm

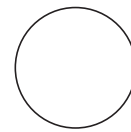
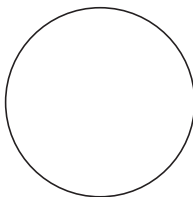
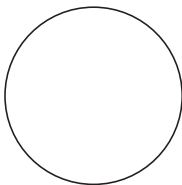

1105 Ø 14 mm 1149 Ø 19 mm 1139 Ø 27 mm

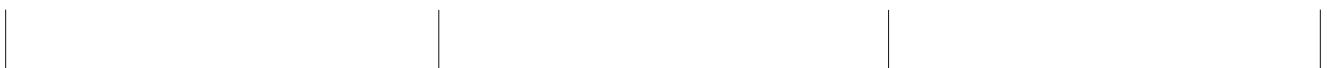
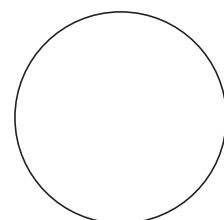
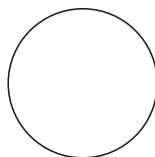
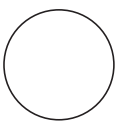

7) Verschiedene Figuren

1403 Ø 29 mm 1019 21 x 23 mm 1085 36 x 30mm

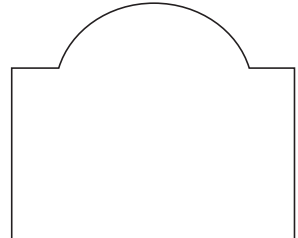
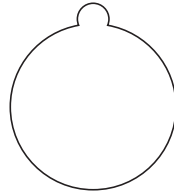
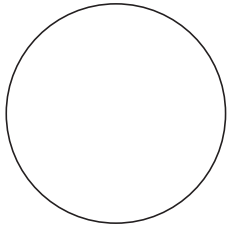

1061 20 x 20 mm 1373 30,2 x 30,3 mm 1042 35,8 x 29,9 mm

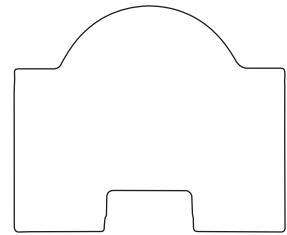
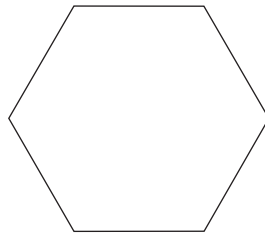
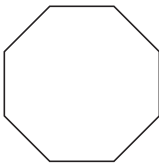

1142 20 x 15 mm 1132 30 x 34 mm 1160 35 x 29 mm

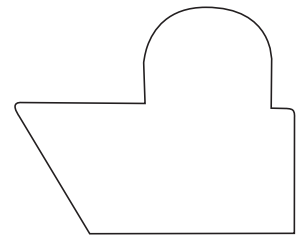
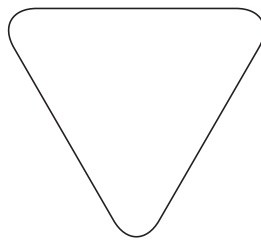
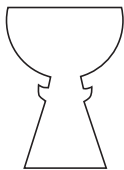

1116 33 x 33 mm 1098 28 x 34 mm 1130 16 x 21 mm

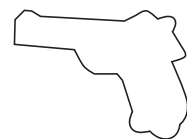
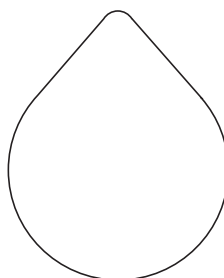
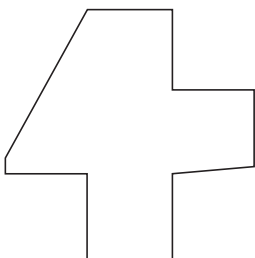

7) Verschiedene Figuren

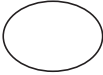
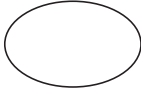
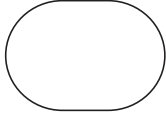
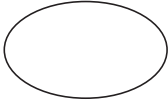
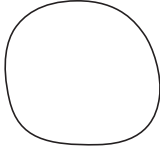
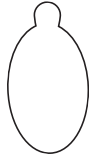
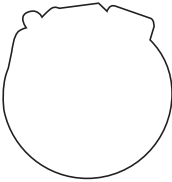
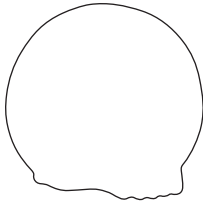
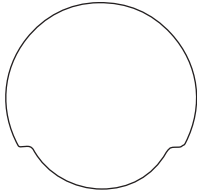
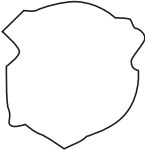
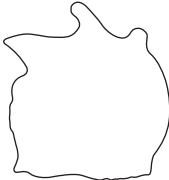
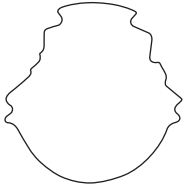
1055	12 x 8 mm	1005	16 x 10 mm	1112	20 x 13 mm
					
1021	20 x 12 mm	1191	21 x 19 mm	1169	10 x 19 mm
					
1138	Ø 22 mm	1394	Ø 26 mm	1386	Ø 25,5 mm
					
1320	Ø 20 mm	1392	22 x 24 mm	1384	23,5 x 24 mm
					

7) Verschiedene Figuren

1308 8 mm 1195 25 x 7 mm 1198 19 x 15 mm

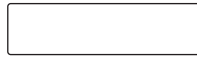

1171 10 x 26 mm 1201 20 x 12 mm 1141 18 x 8 mm



1104 15 x 12 mm 1401 24 x 7 mm 1094 31 x 23 mm



1018 5 x 5 mm 1088 30 x 30 mm 1195 25 x 7 mm

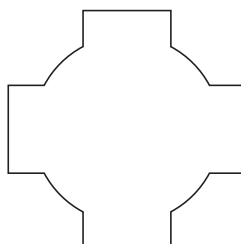

7) Verschiedene Figuren

1379	19 x 23 mm	1361	23,5 x 22,5 mm	1369	19,5 x 27 mm
------	------------	------	----------------	------	--------------

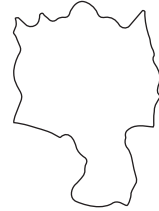
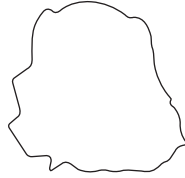
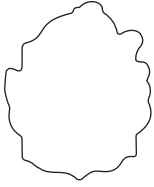

1353	23,5 x 18,5 mm	1382	23 x 27 mm	1351	19 x 23 mm
------	----------------	------	------------	------	------------

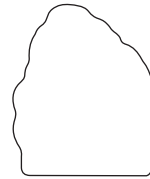
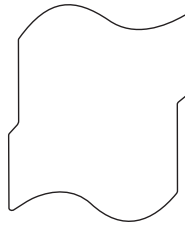
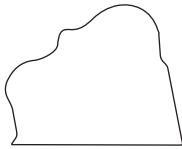

1202	42,7 x 12,7 mm	1204	41 x 12,5 mm	1119	32 x 19 mm
------	----------------	------	--------------	------	------------

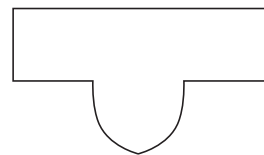
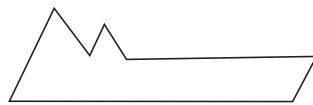
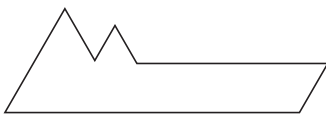

1066	13 x 15 mm	1344	16 x 25,5 mm	1376	17 x 25 mm
------	------------	------	--------------	------	------------

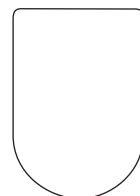
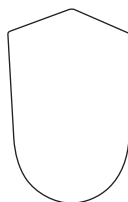
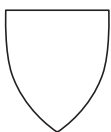

7) Verschiedene Figuren

1359	24 x 13 mm	1389	27 x 18 mm	1388	34 x 25 mm
------	------------	------	------------	------	------------

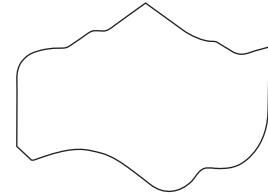
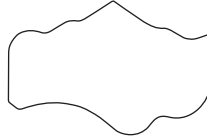
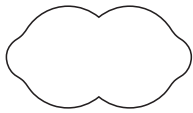

1399	23 x 33 mm	1398	19 x 29 mm	1111	27,5 mm
------	------------	------	------------	------	---------

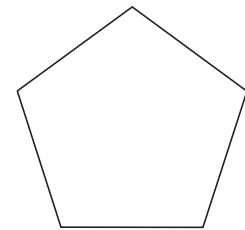
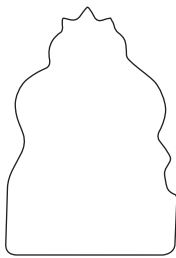

1216	Ø 7 mm	1196	Ø 9 mm	1401	24 x 7 mm
------	--------	------	--------	------	-----------



1126	42 x 15 mm	1007	33 x 13 mm	1412	15 x 18 mm
------	------------	------	------------	------	------------

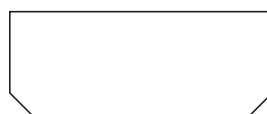

--	--	--	--	--	--



Pins

Übersicht Doppelschnitte:
Verschiedene Figuren

1388 / 1389

1388.1389.1

1386 / 1384

1386.1384.1

1382 / 1379

1382.1379.1

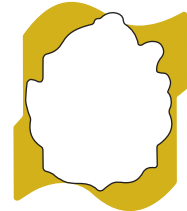
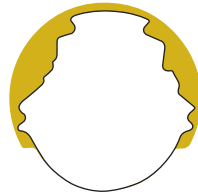
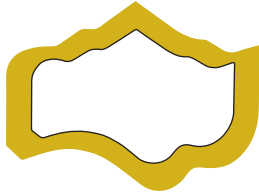

1394 / 1392

1394.1392.1

1399 / 1398

1399.1398.1

1126 / 1007

1126.1007.1

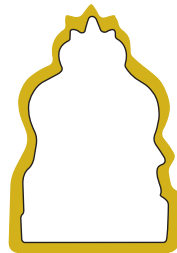

1344 / 1066

1344.1066.1

1344 / 1066

1344.1066.2

1344 / 1066

1344.1066.3

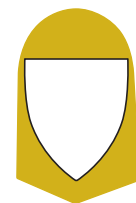
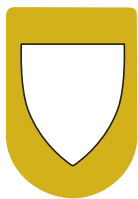

1195 / 1066

1195.1066.1

1202 / 1066

1202.1066.1

1198 / 1104

1198.1104.1

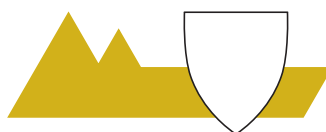
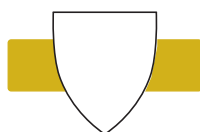

1374 / 1149 1374.1149.1 1374 / 1039 1374.1039.1 1139 / 1150 1139.1150.1

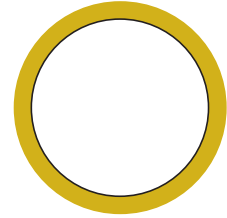
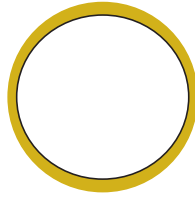
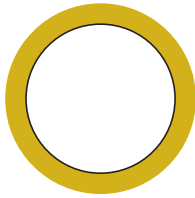

1403 / 1374 1403.1374.1 1149 / 1105 1149.1105.1 1021 / 1055 1021.1055.1

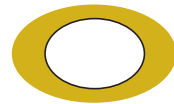
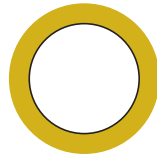
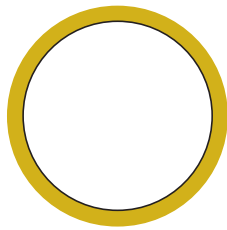

1191 / 1005 1191.1005.1 1112 / 1005 1112.1005.1 1061 / 1120 1061.1120.1

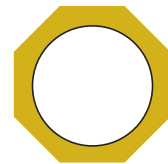
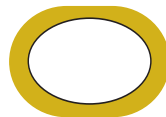
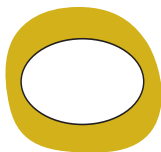

1344 / 1412 1344.1412.1 1139 / 1412 1139.1412.1 1382 / 1411 1382.1412.1

