



## Schnittwerkzeugkatalog





### Lieber Leser

Nachfolgend finden Sie über hundert Umrissformen, die Sie für die Gestaltung Ihrer Plakette, Medaille oder Ihres Abzeichens verwenden können.

Weitere Formen und Ideen besprechen wir gerne mit Ihnen persönlich. Wir beraten Sie umfassend von der Skizze bis zur Logistikhösung.

### Ihre Vorteile:

- Fachmännische und persönliche Beratung
- Qualitativ erstklassige Verarbeitung
- Innovative, technische Lösungsungen
- Jahrzehntelange Erfahrung
- Produktionsstandort in der Schweiz
- Alles aus einer Hand: prägen, drucken und Systemlösungen
- Schnell und flexibel
- Attraktives Preis-Leistungsverhältnis
- Termingerechte Auslieferung

### Die Prägetech AG

Seit der Gründung im Jahre 1996 sind wir in der Herstellung von edlen und hochwertigen Fasnachtsplaketten, Medaillen, Münzen und Abzeichen tätig. Verarbeitet werden dabei hauptsächlich Kupfer und Messing, aber auch Neusilber, Aluminium und Kunststoffe.

In den letzten Jahren wurde aufgrund steigender Nachfrage das Leistungspaket der Firma ausgebaut. Nun stehen weitere Bereiche, wie z.B. das Drucken (Tampondruck) sowie das Systemgeschäft (Baugruppenmontage, Logistikhösungen usw.) für Sie zur Verfügung. – Dabei steht die «Leidenschaft für Ihr Produkt» im Zentrum, sei dies beim Prägen, Stanzen, Gravieren, Drucken, Lackieren, Reinigen, Vergolden, Lötten oder einem der vielen weiteren Herstellschritte.

Prägetech AG ist am Puls der Zeit und für Sie immer auf der Suche nach technischen und gestalterischen Innovationen. Unsere Produkte mit starken emotionalen und ausdrucksstarken Botschaften werden Sie überzeugen.

Mit Freude am Detail pflegen wir Schweizer Handwerk und produzieren für Sie in höchster Qualität. Fordern Sie uns jetzt heraus!



**So gestalten Sie einfach die Vorlage für Ihre neue Fasnachtsplaketten, Medaillen, Münzen oder Abzeichen.** – Hochwertiges Lackieren, Vergolden und interessante Oberflächenstrukturen machen Ihre Plakette zum Sammlerstück.



**Mit unseren Einschnittwerkzeugen steht Ihnen eine Vielfalt von Formen zur Verfügung.** Kopieren Sie sich die Form und skizzieren Sie direkt auf der ausgesuchten Schnittform.



A) Einschnittwerkzeuge

S. 1001

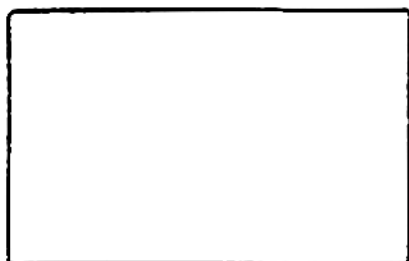

S. 1002

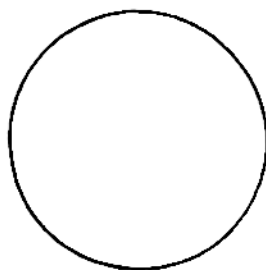

S. 1003

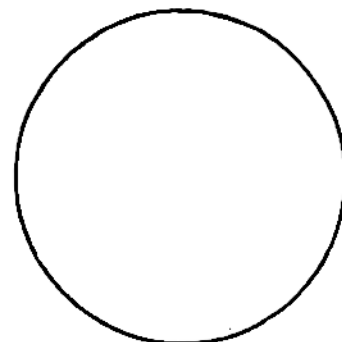

S. 1004

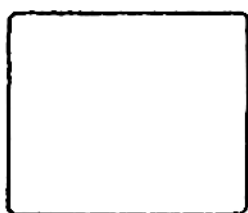

S. 1005



S. 1006

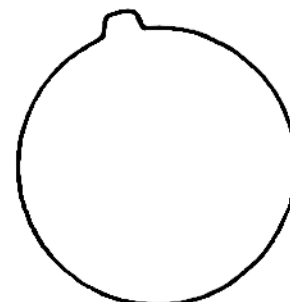

S. 1007

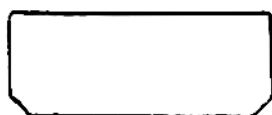

S. 1008

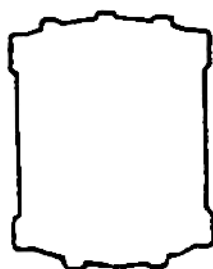

S. 1009

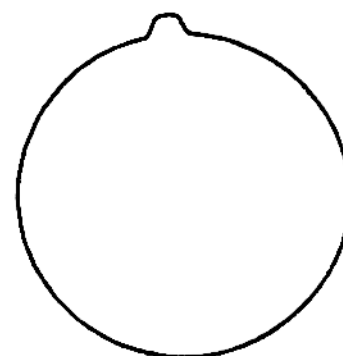

S. 1010 K

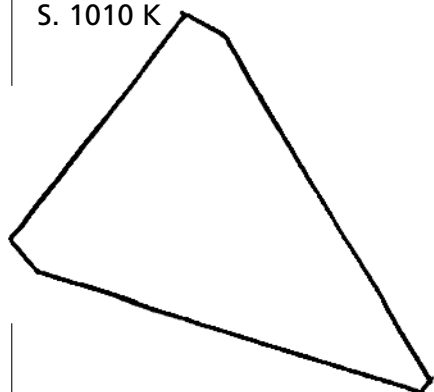

S. 1010 G

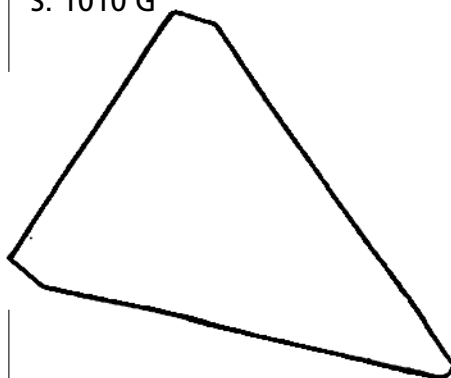

S. 1011

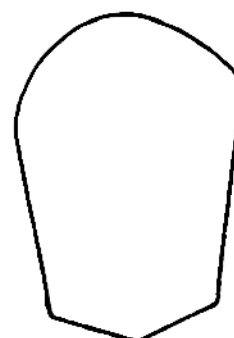

A) Einschnittwerkzeuge

S. 1012

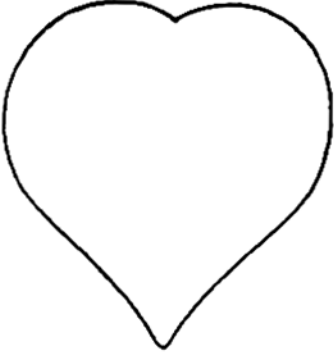

S. 1013 A

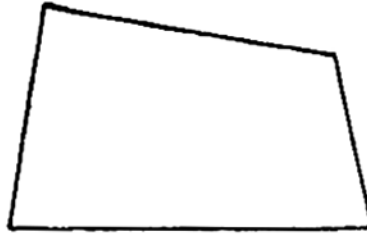

S. 1013 B

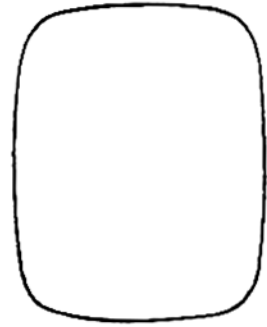

S. 1014 A

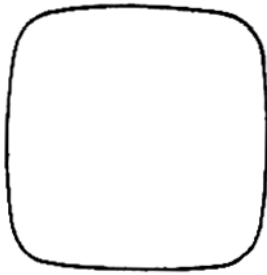

S. 1014 B

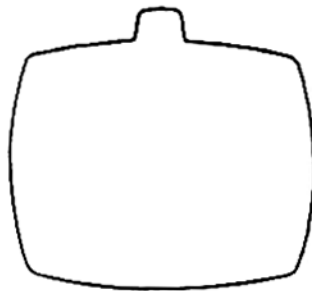

S. 1015



S. 1016

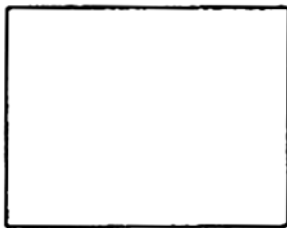

S. 1017

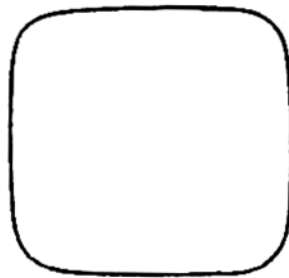

S. 1018



S. 1019



S. 1020

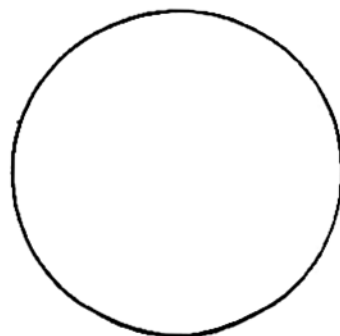

S. 1021



A) Einschnittwerkzeuge

S. 1022

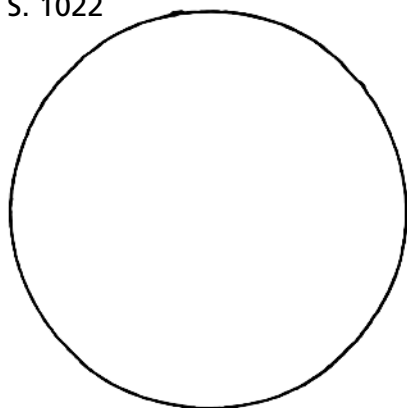

S. 1025

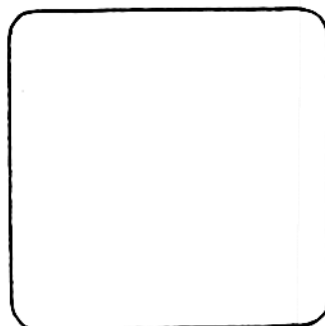

S. 1026



S. 1027

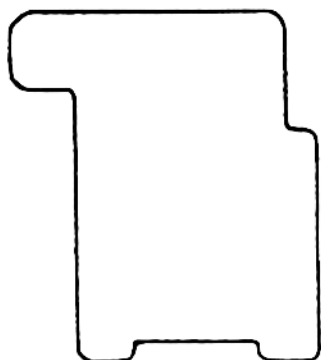

S. 1028

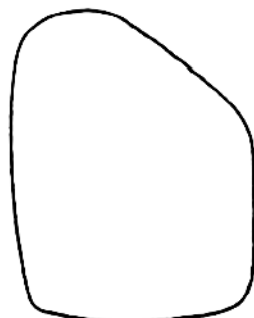

S. 1029

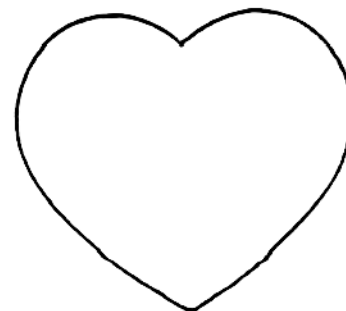

S. 1030

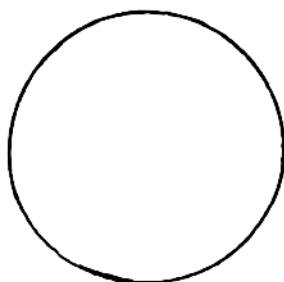

S. 1031

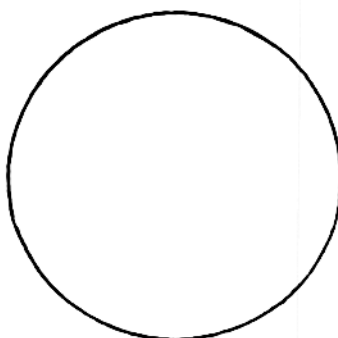

S. 1032

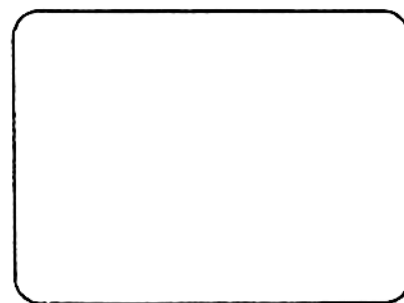

S. 1033

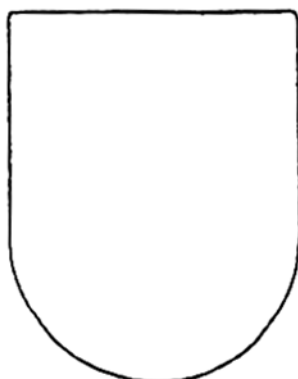

S. 1034

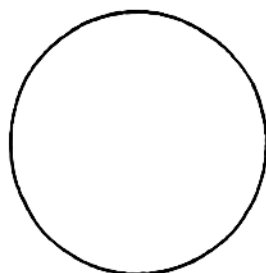

S. 1035



A) Einschnittwerkzeuge

S. 1036

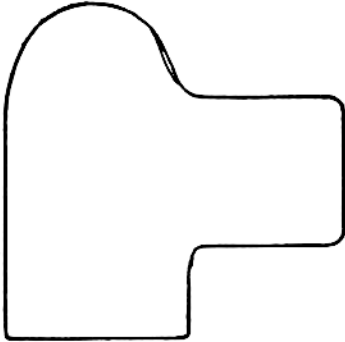

S. 1037

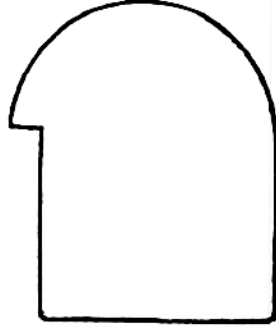

S. 1038

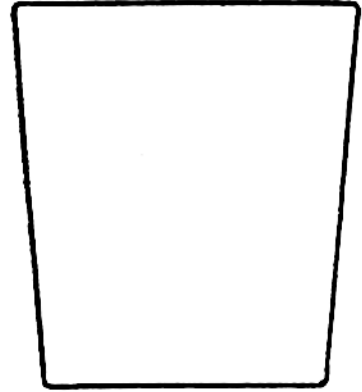

S. 1039

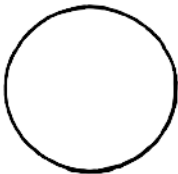

S. 1040

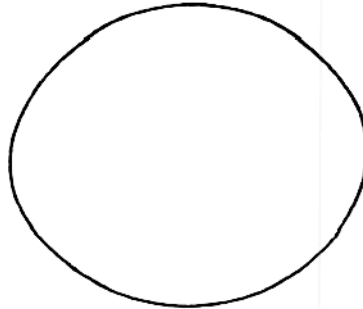

S. 1042

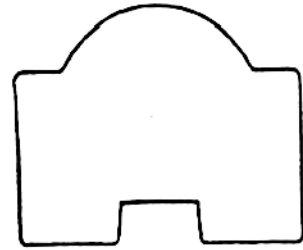

S. 1043

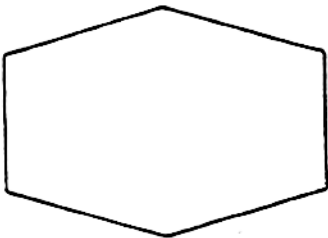

S. 1044

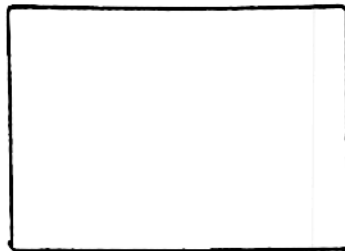

S. 1045

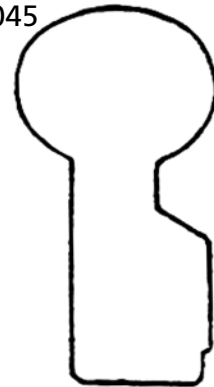

S. 1046

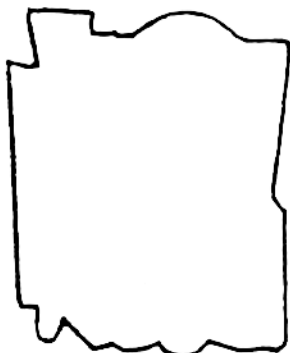

S. 1047

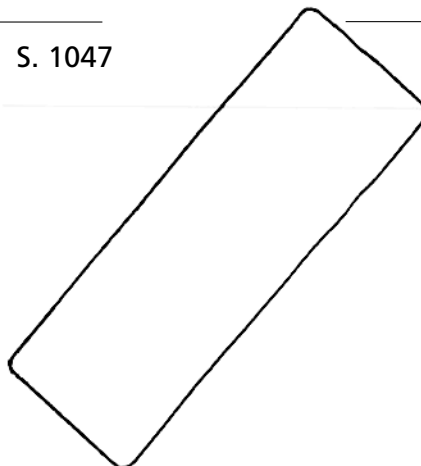

S. 1048

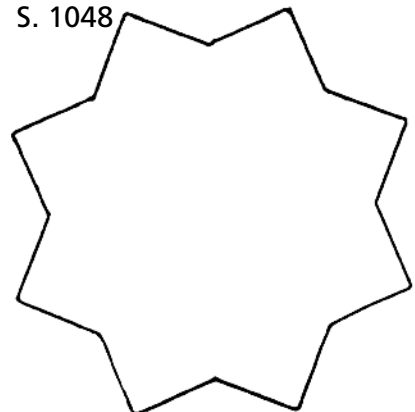

A) Einschnittwerkzeuge

S. 1049

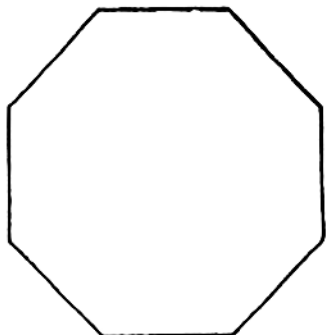

S. 1050

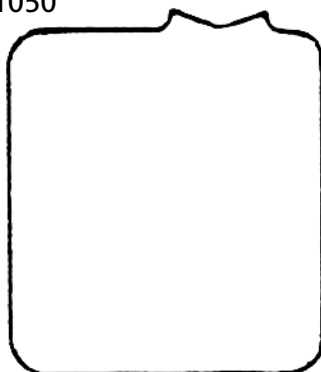

S. 1051

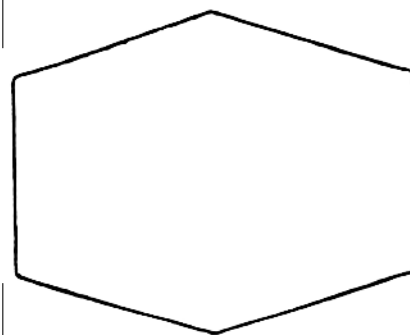

S. 1052

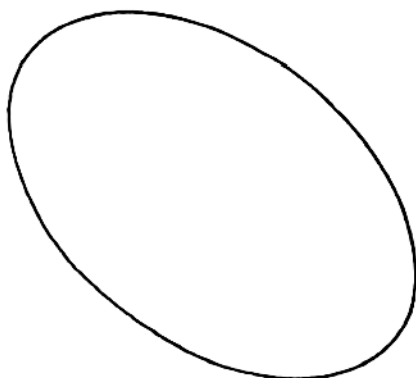

S. 1053

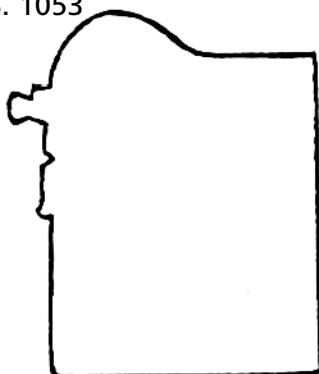

S. 1055



S. 1056

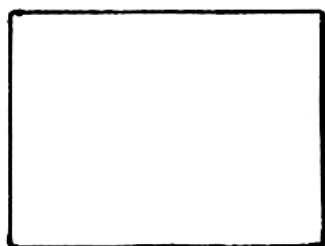

S. 1057

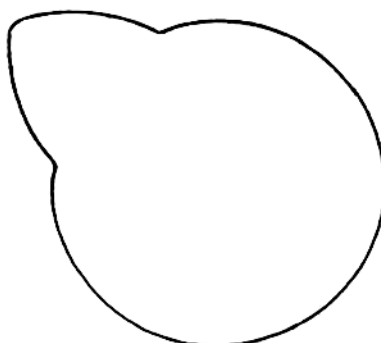

S. 1058

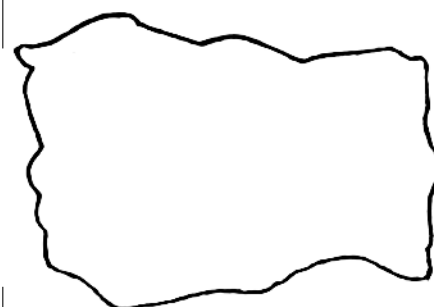

S. 1059

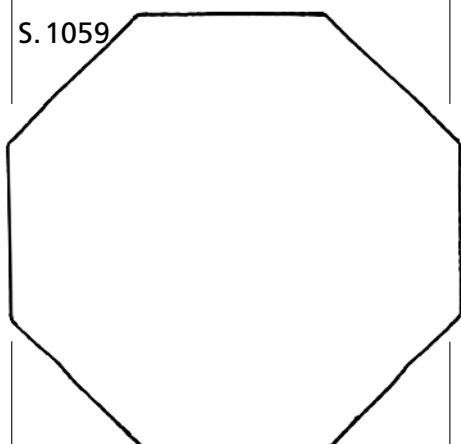

S. 1060

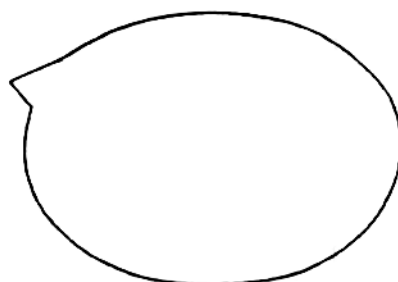

S. 1061

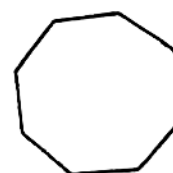



A) Einschnittwerkzeuge

S. 1062

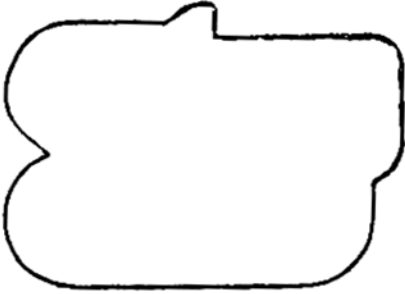

S. 1063

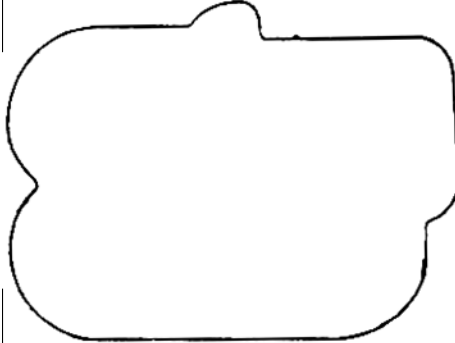

S. 1065

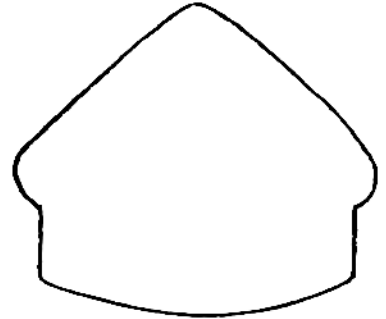

S. 1066

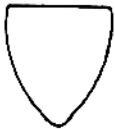

S. 1067



S. 1068

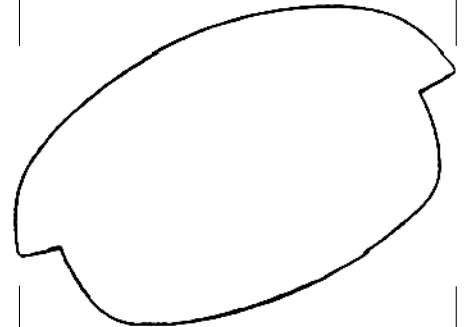

S. 1069

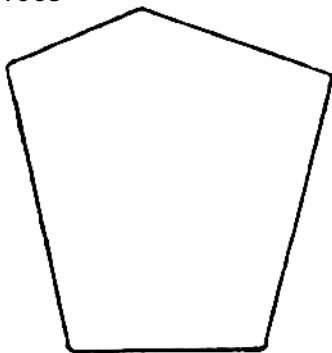

S. 1070

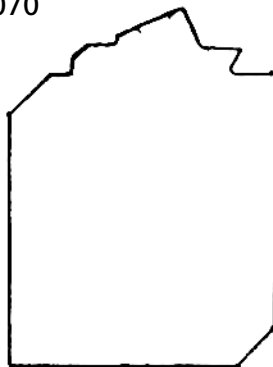

S. 1071

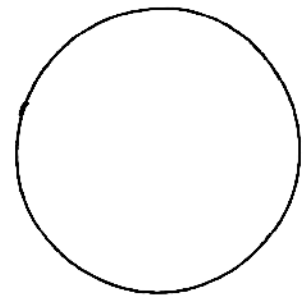

S. 1072



S. 1073



S. 1074

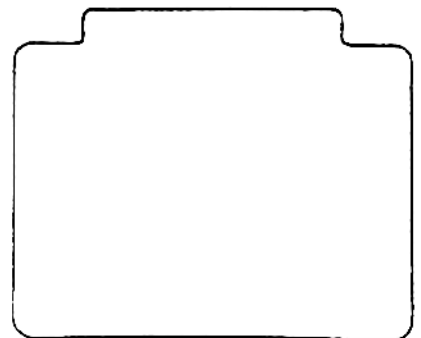

A) Einschnittwerkzeuge

S. 1075

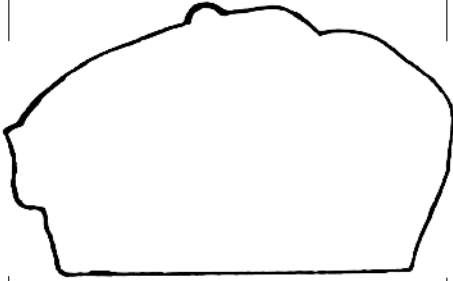

S. 1076

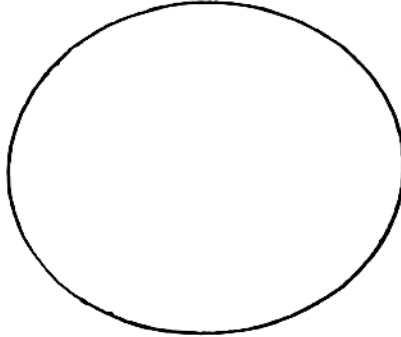

S. 1077

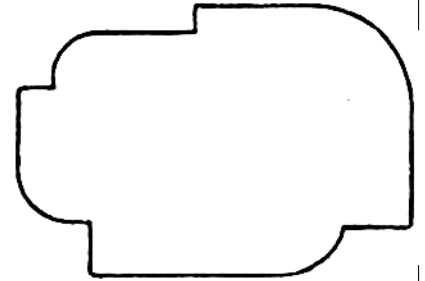

S. 1078

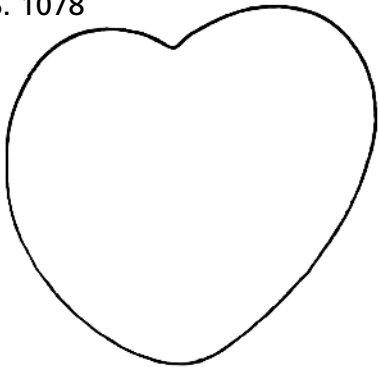

S. 1079

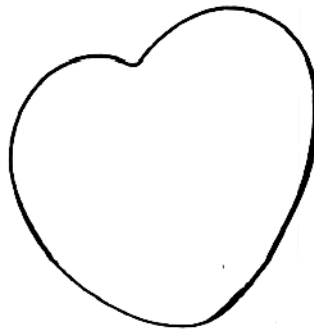

S. 1080

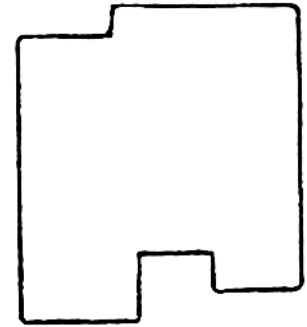

S. 1081

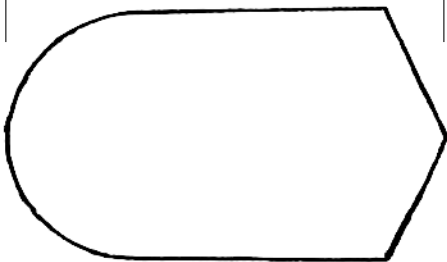

S. 1082

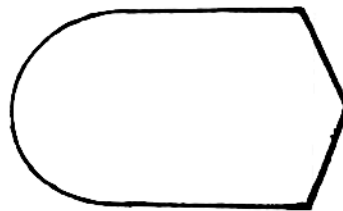

S. 1083

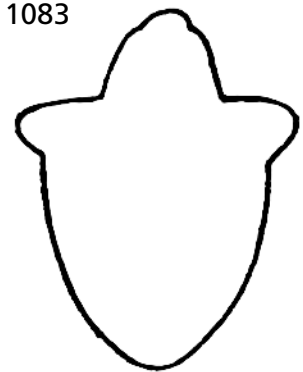

S. 1084

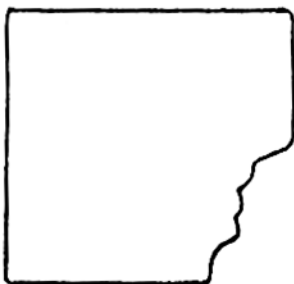

S. 1085

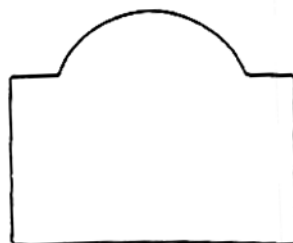

S. 1086

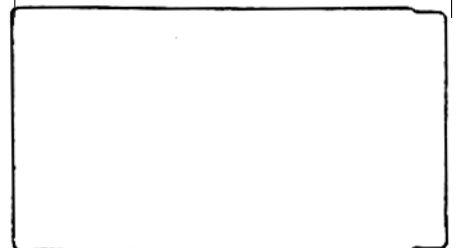

A) Einschnittwerkzeuge

S. 1087

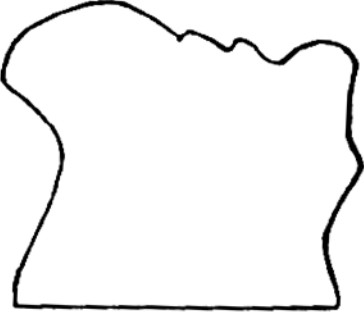

S. 1088

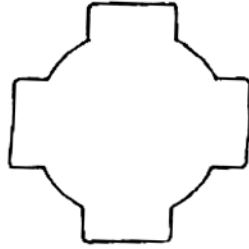

S. 1089

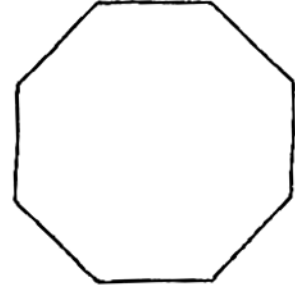

S. 1090

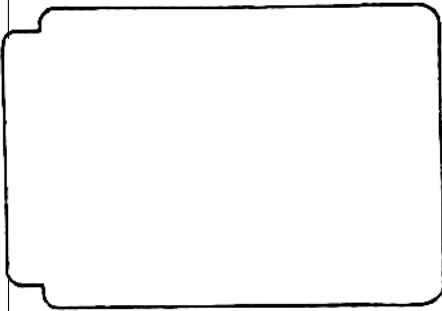

S. 1091

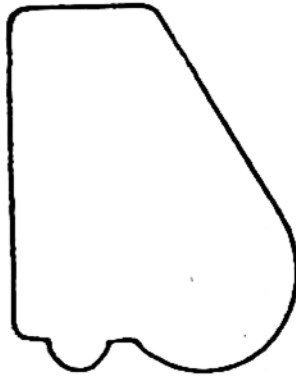

S. 1092

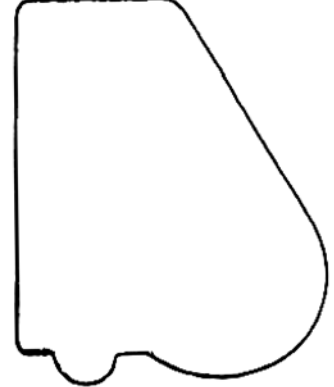

S. 1093

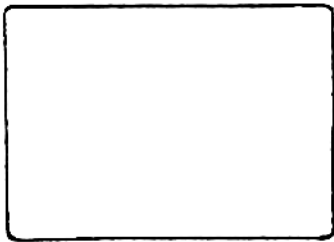

S. 1094



S. 1095

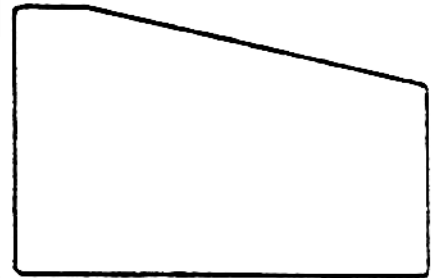

S. 1096



S. 1097

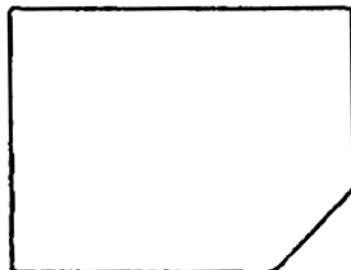

S. 1098

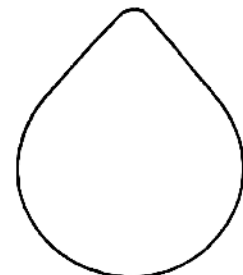

A) Einschnittwerkzeuge

S. 1099

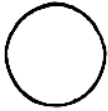

S. 1101

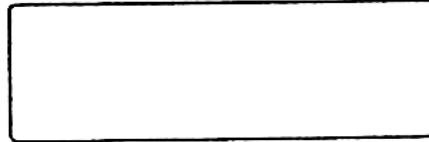

S. 1101

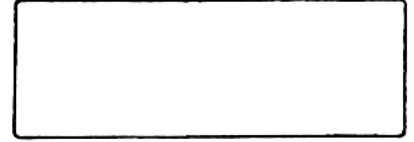

S. 1102

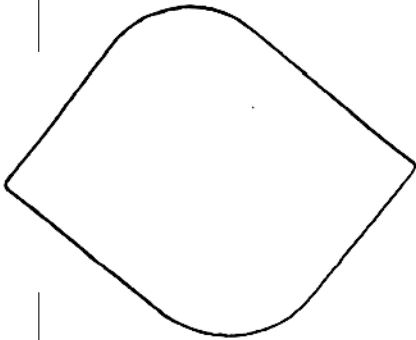

S. 1103

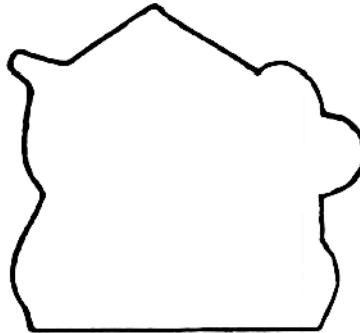

S. 1104



S. 1105

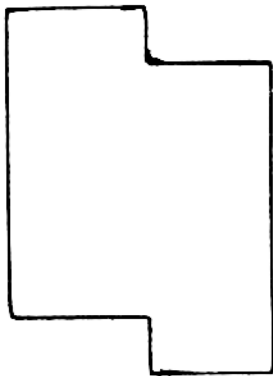

S. 1107

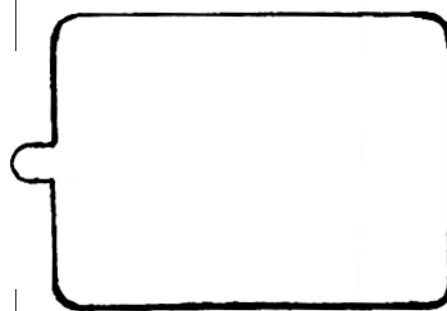

S. 1108

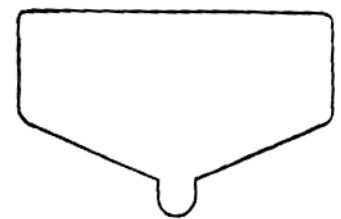

S. 1109



S. 1110



S. 1105

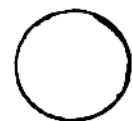

A) Einschnittwerkzeuge

S. 1111

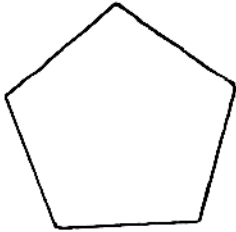

S. 1112

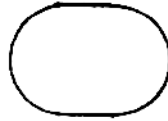

S. 1113

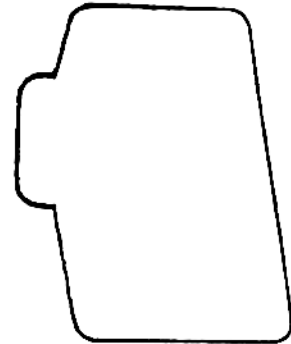

S. 1114

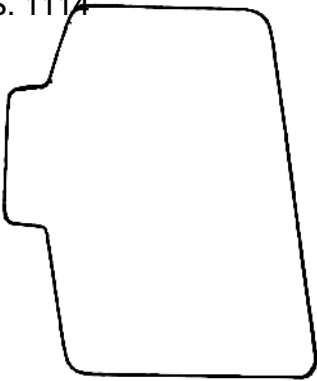

S. 1115

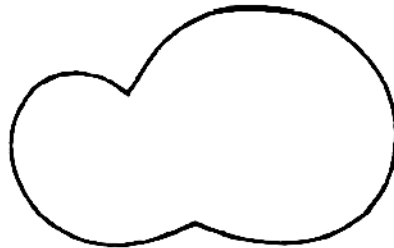

S. 1116

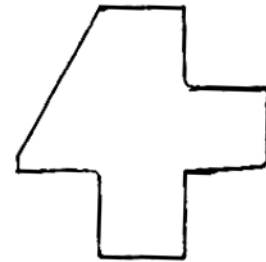

S. 1117

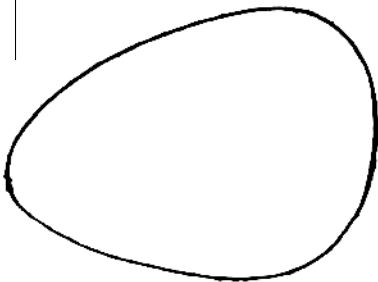

S. 1118

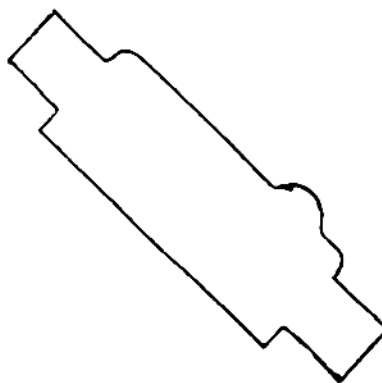

S. 1119

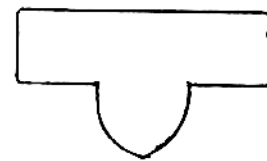

S. 1120

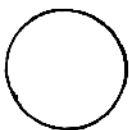

S. 1121

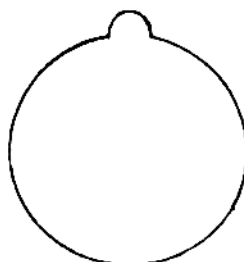

S. 1122

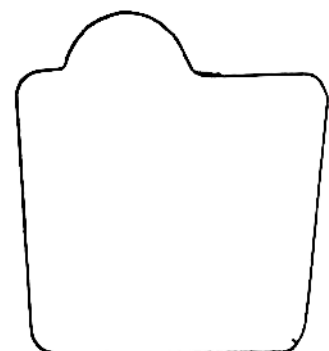

A) Einschnittwerkzeuge

S. 1123

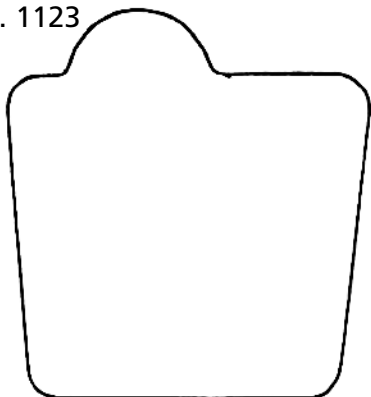

S. 1124



S. 1126

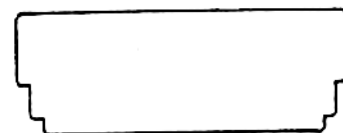

S. 1127

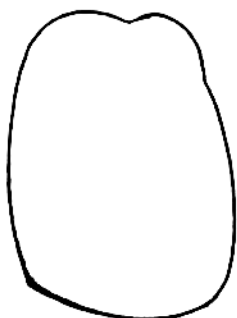

S. 1130



S. 1131



S. 1132

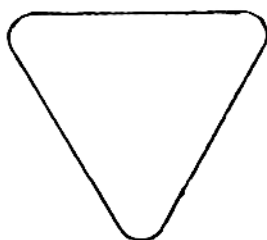

S. 1133

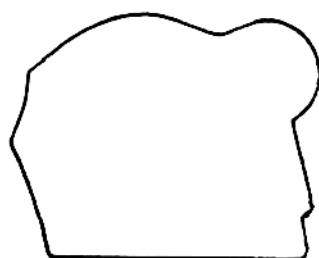

S. 1135

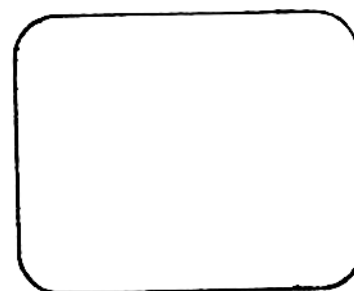

S. 1136

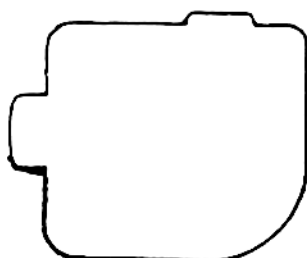

S. 1137

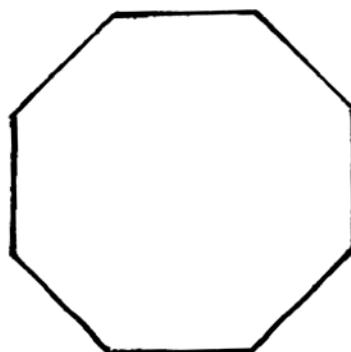

S. 1138



A) Einschnittwerkzeuge

S. 1139

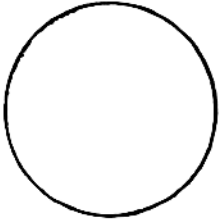

S. 1140

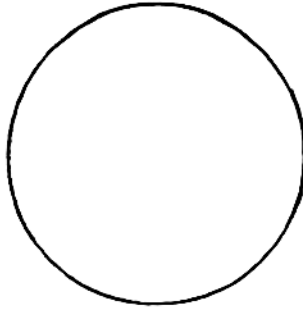

S. 1141

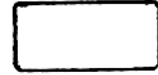

S. 1142



S. 1143

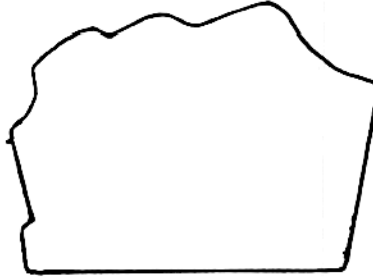

S. 1145

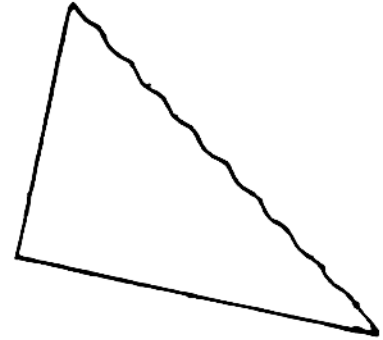

S. 1148

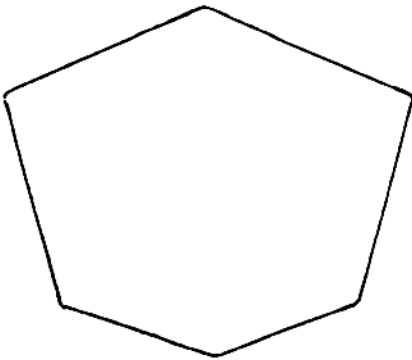

S. 1149

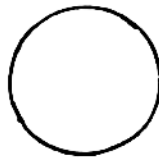

S. 1150

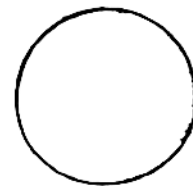

S. 1151

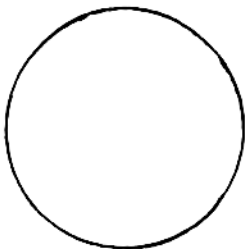

S. 1152

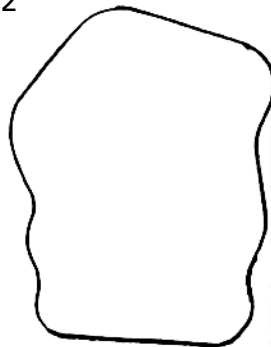

S. 1153

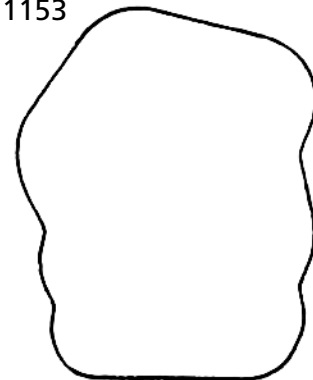

A) Einschnittwerkzeuge

S. 1154

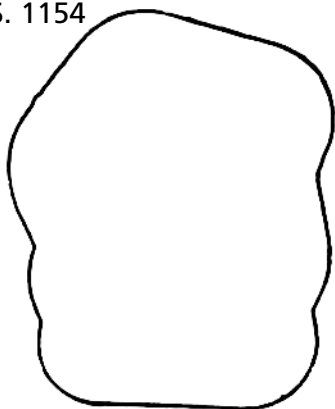

S. 1155



S. 1156



S. 1157



S. 1158

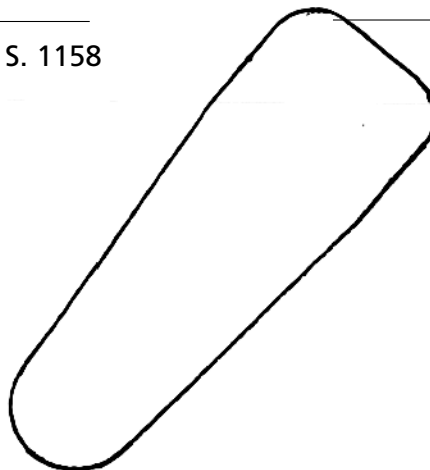

S. 1160

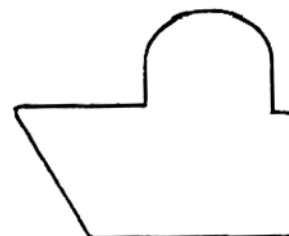

S. 1161

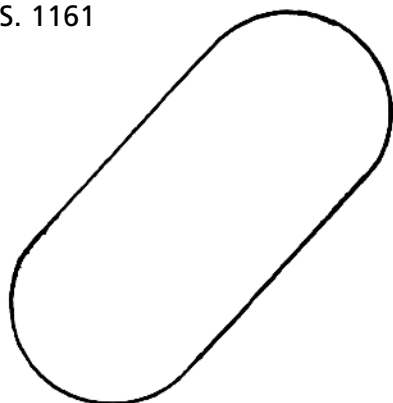

S. 1162

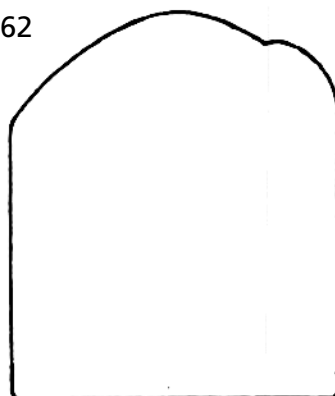

S. 1163

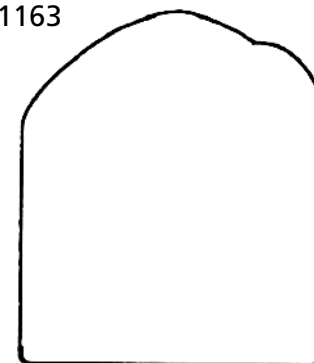

S. 1164

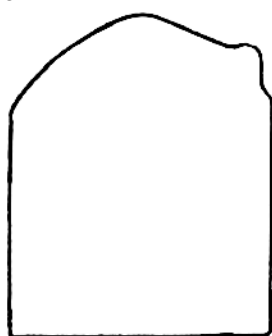

S. 1165

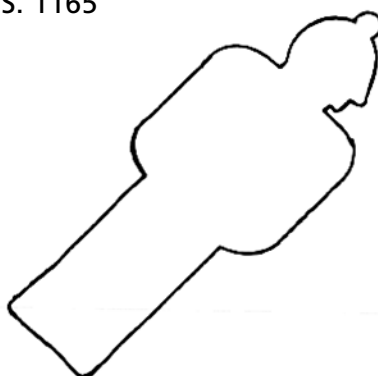

S. 1166





A) Einschnittwerkzeuge

S. 1167

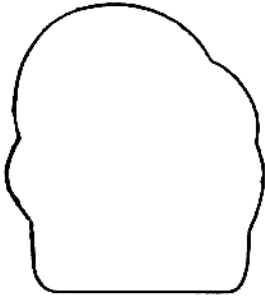

S. 1168

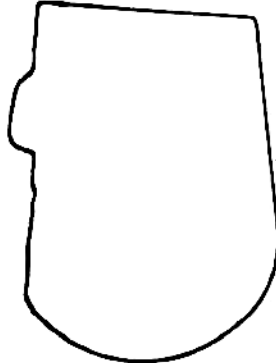

S. 1169



S. 1170

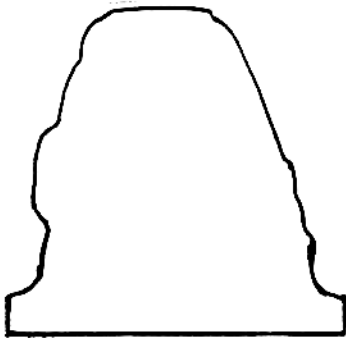

S. 1171

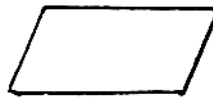

S. 1172

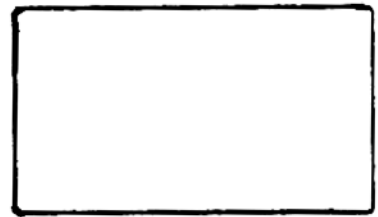

S. 1173

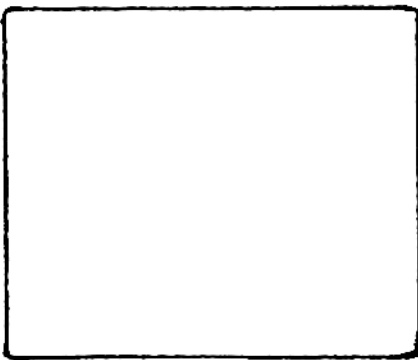

S. 1174

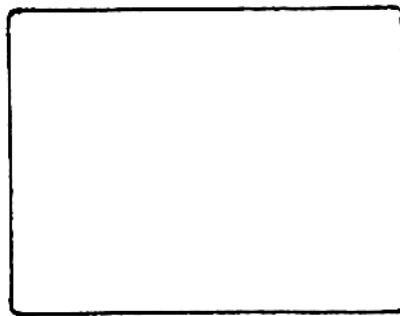

S. 1345/K./Lu

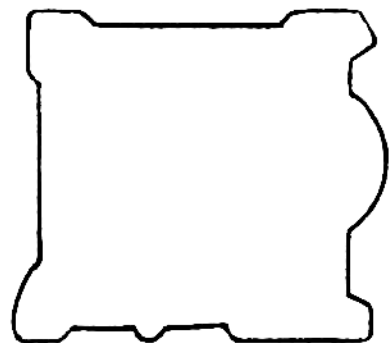

S. 1175

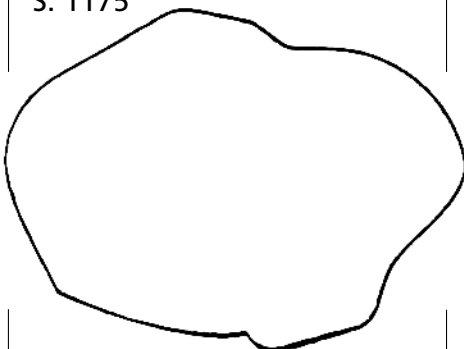

S. 1176



S. 1177

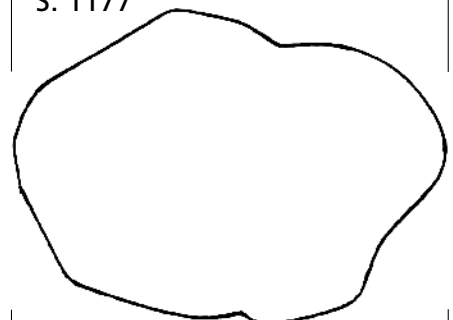

A) Einschnittwerkzeuge

S. 1178

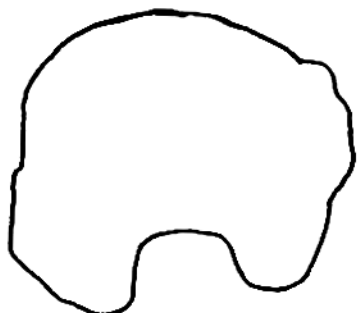

S. 1179

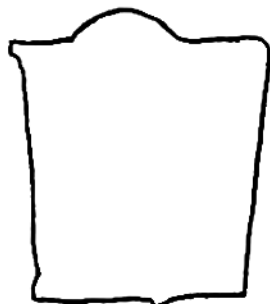

S. 1180

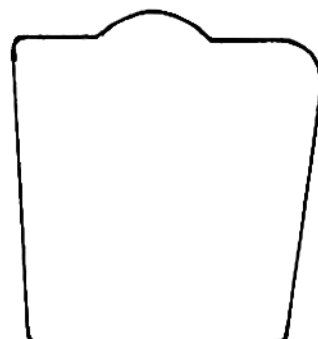

S. 1181

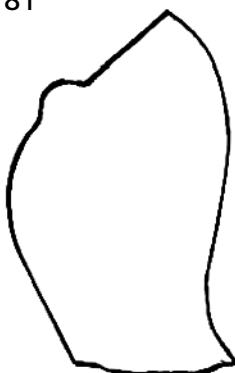

S. 1182

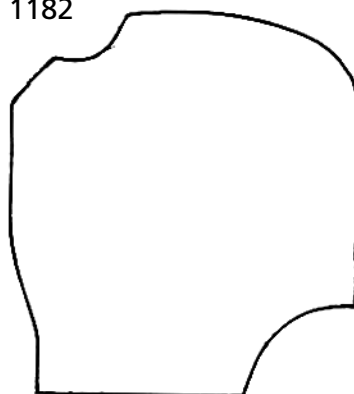

S. 1183

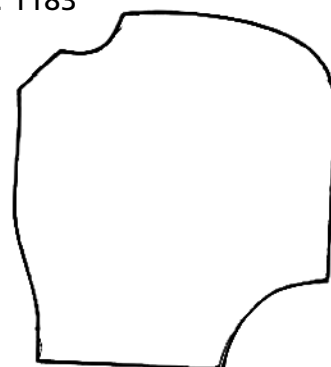

S. 1184

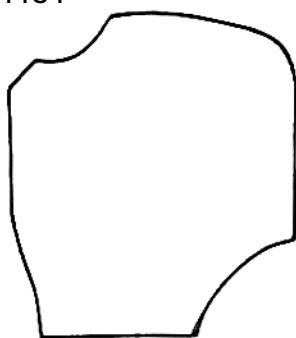

S. 1185

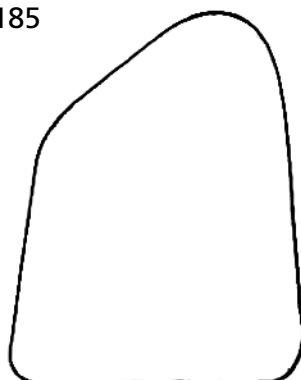

S. 1186 A

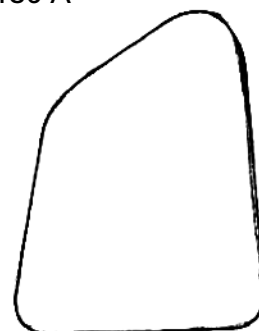

S. 1186 B

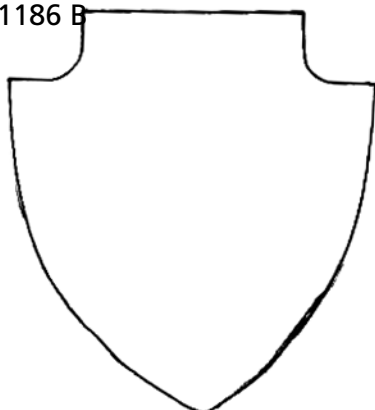

S. 1187

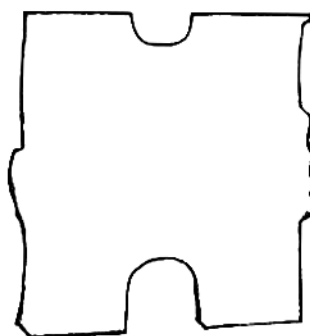

S. 1188

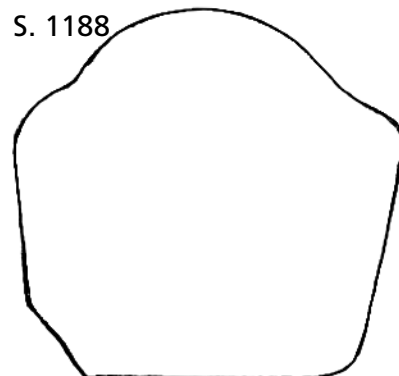

A) Einschnittwerkzeuge

S. 1189

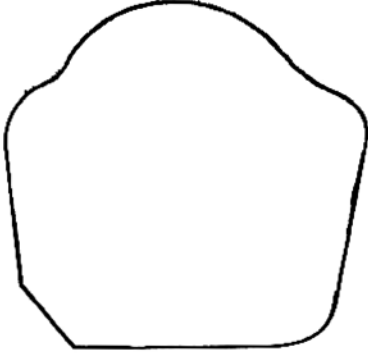

S. 1190

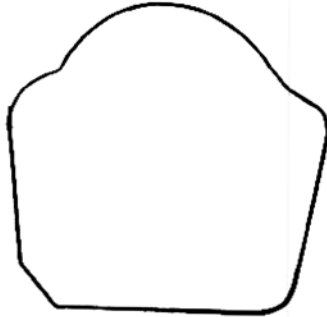

S. 1191

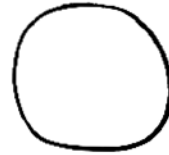

S. 1192



S. 1193



S. 1194

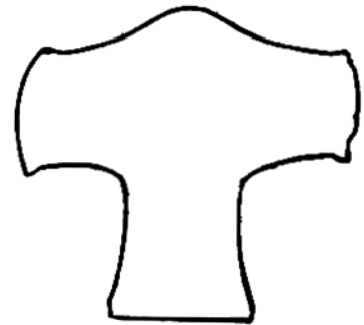

S. 1195



S. 1196



S. 1197

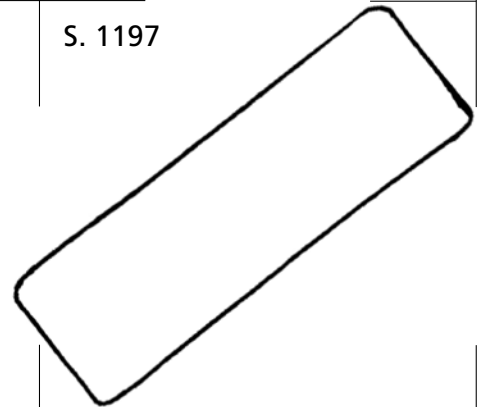

S. 1198

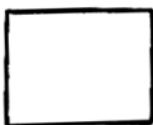

S. 1199

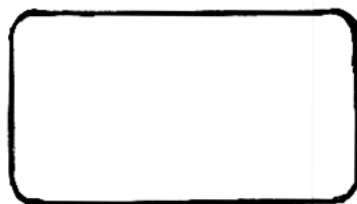

S. 1200

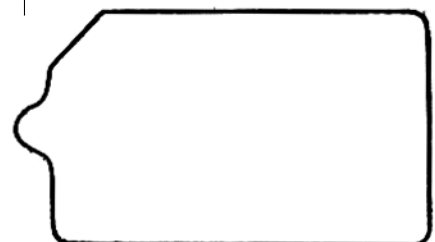

A) Einschnittwerkzeuge

S. 1201



S. 1202

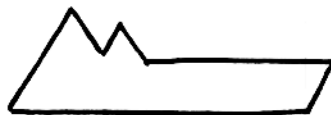

S. 1203



S. 1204

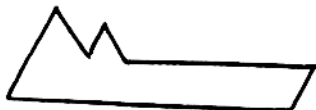

S. 1205

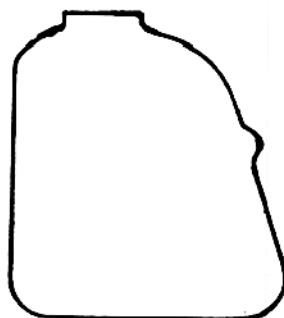

S. 1206

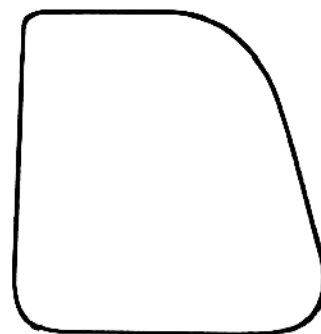

S. 1207

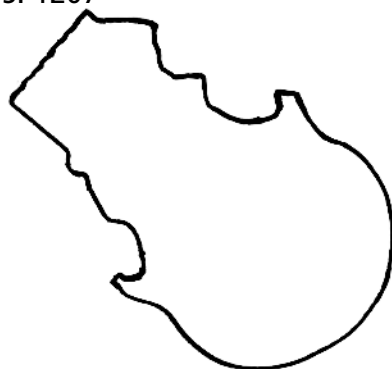

S. 1208



S. 1209

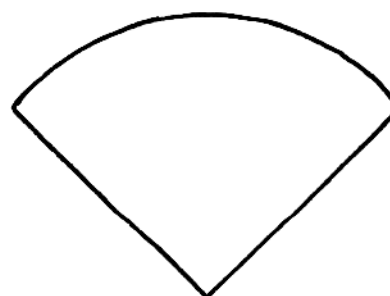

S. 1210

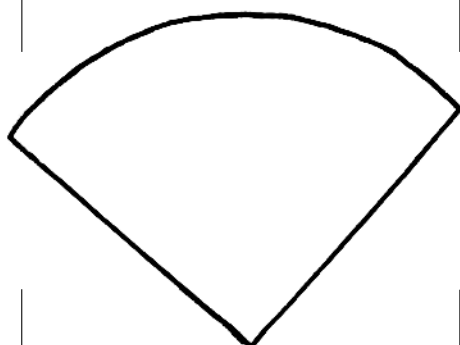

S. 1211

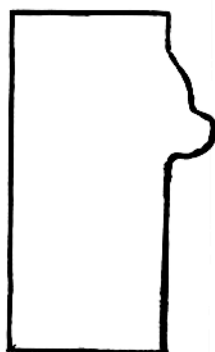

S. 1212

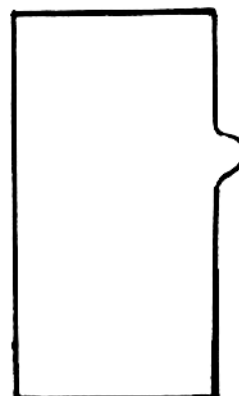

A) Einschnittwerkzeuge

S. 1215

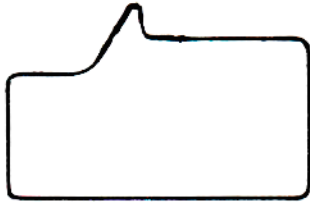

S. 1216



S. 1217



S. 1218

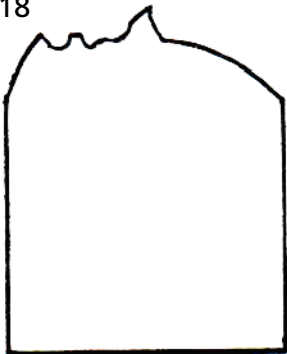

S. 1219

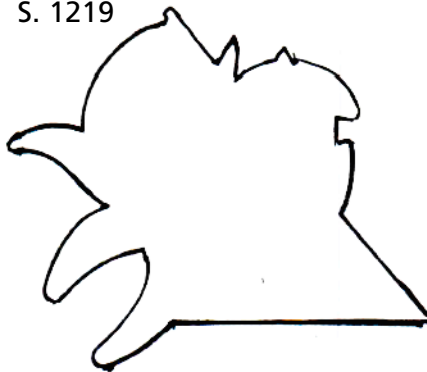

S. 1300



S. 1301



S. 1302



S. 1303

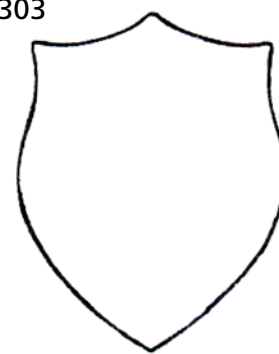

S. 1304

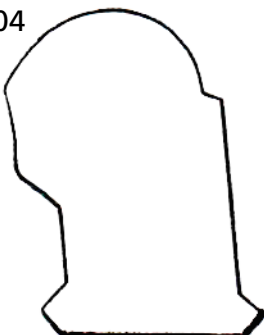



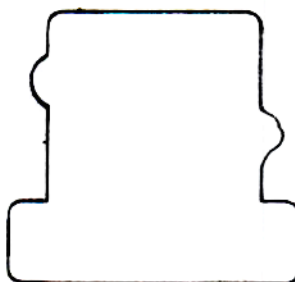

S. 1305

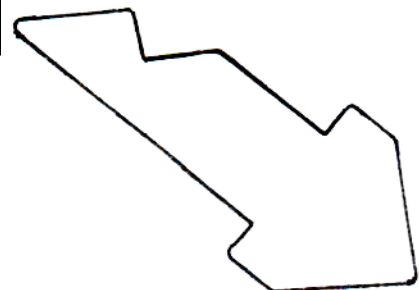

S. 1306

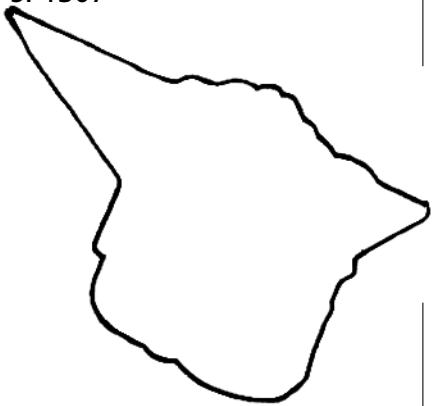

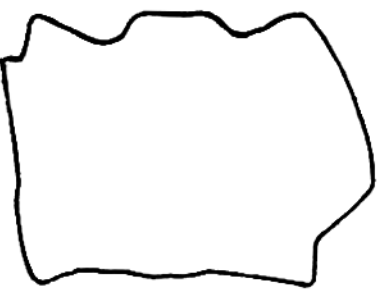
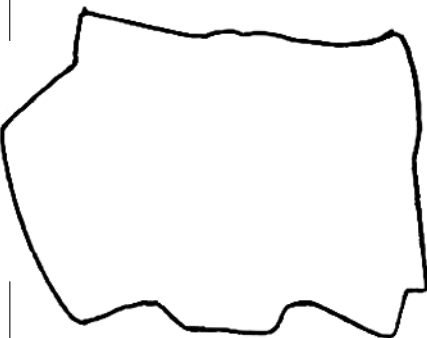
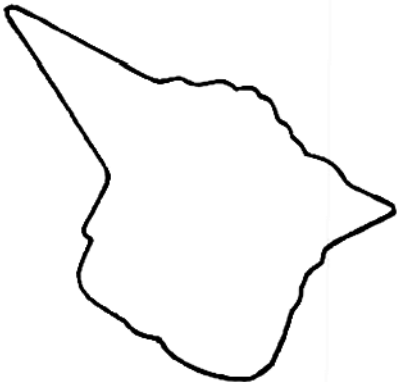
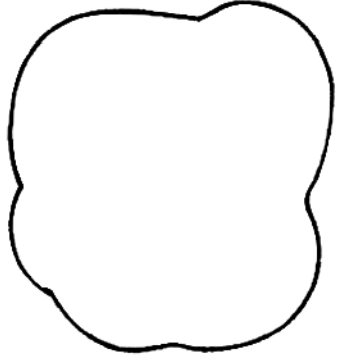
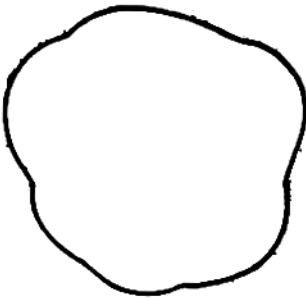
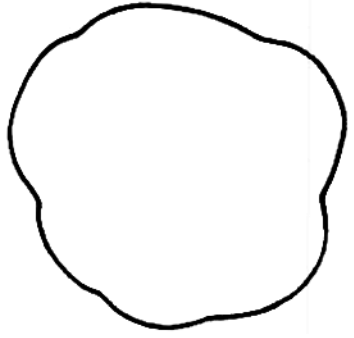
A) Einschnittwerkzeuge

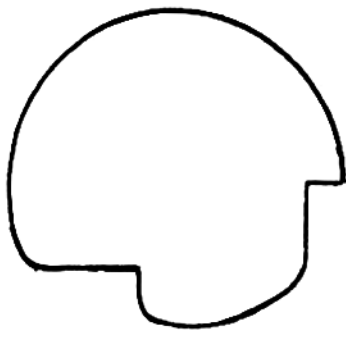
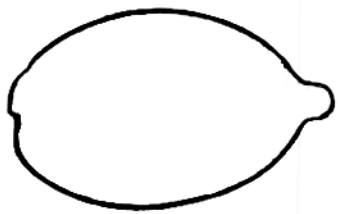
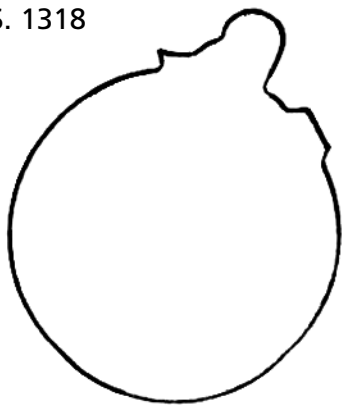
|                                                                                                |                                                                                                |                                                                                                  |
|------------------------------------------------------------------------------------------------|------------------------------------------------------------------------------------------------|--------------------------------------------------------------------------------------------------|
| S. 1307<br>   | S. 1308<br>   | S. 1309<br>   |
| S. 1310<br>  | S. 1311<br> | S. 1312<br>  |
| S. 1313<br> | S. 1314<br> | S. 1315<br> |
| S. 1316<br> | S. 1317<br> | S. 1318<br> |



A) Einschnittwerkzeuge

S. 1319

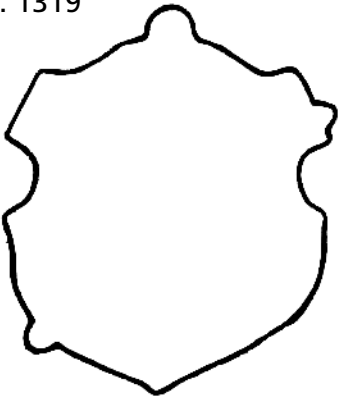

S. 1320



S. 1321

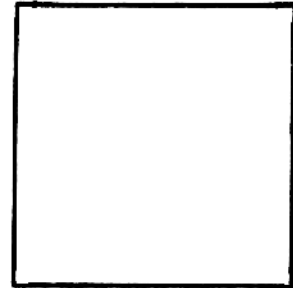

S. 1322

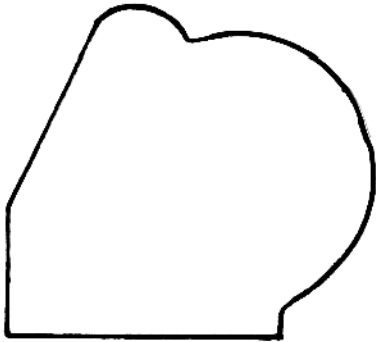

S. 1323

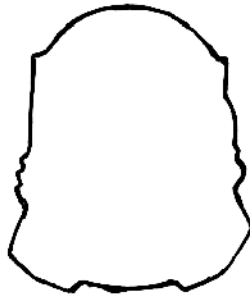

S. 1324

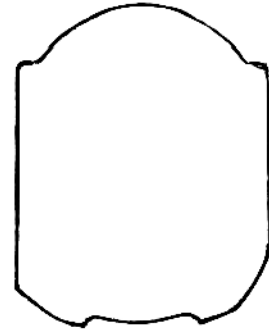

S. 1325

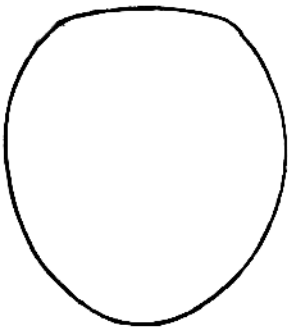

S. 1326

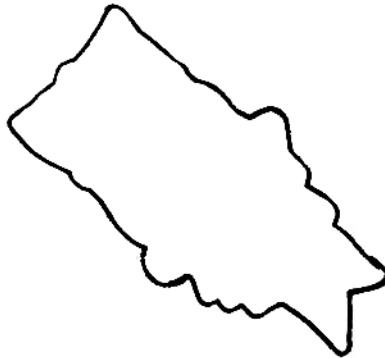

S. 1327

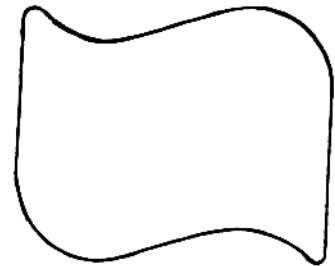

S. 1328

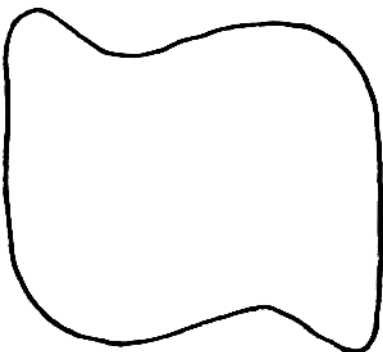

S. 1329

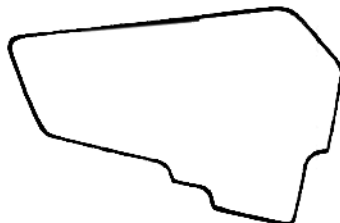

S. 1330

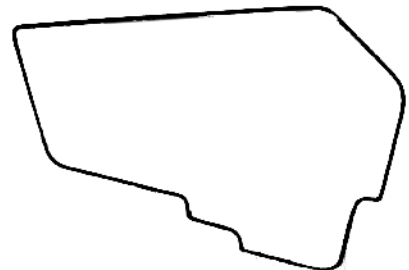

A) Einschnittwerkzeuge

S. 1331

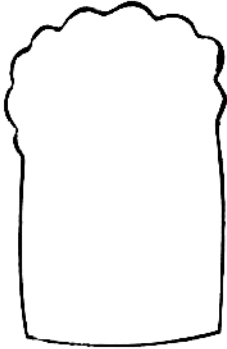

S. 1332

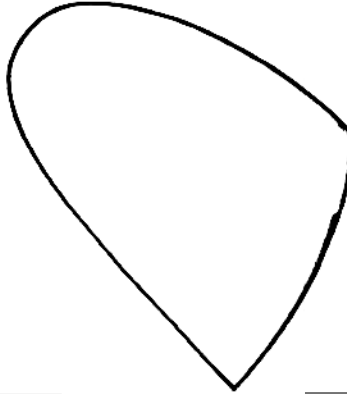

S. 1333



S. 1334

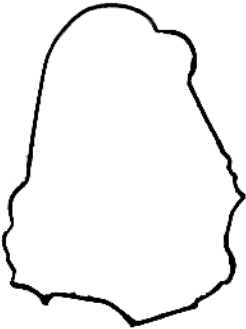

S. 1335



S. 1336

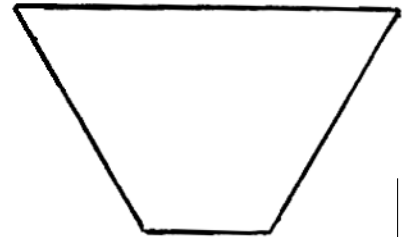

S. 1337



S. 1338

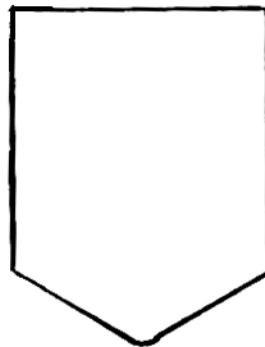

S. 1339



S. 1340



S. 1341

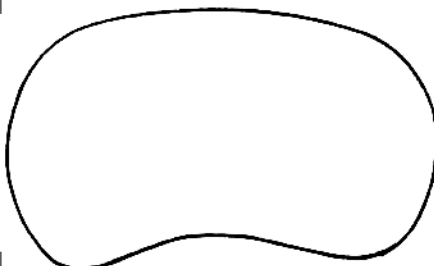

S. 1342

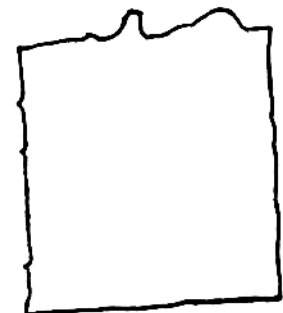



A) Einschnittwerkzeuge

S. 1343

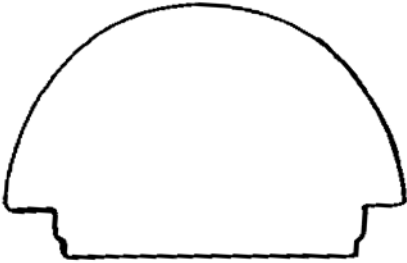

S. 1344



S. 1345

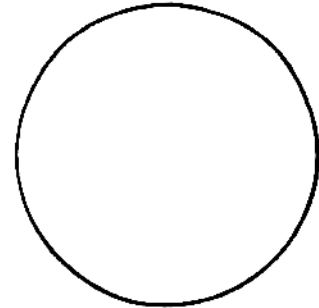

S. 1346

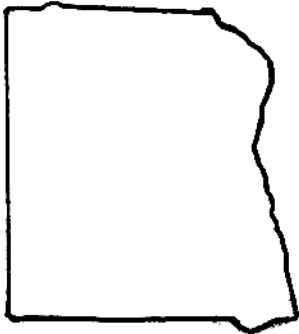

S. 1347

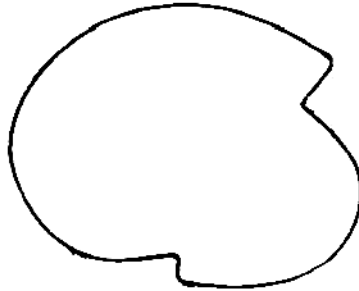

S. 1348

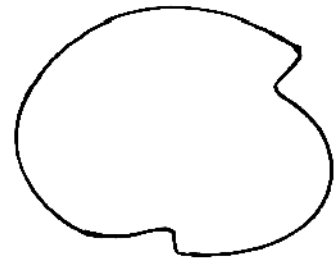

S. 1349

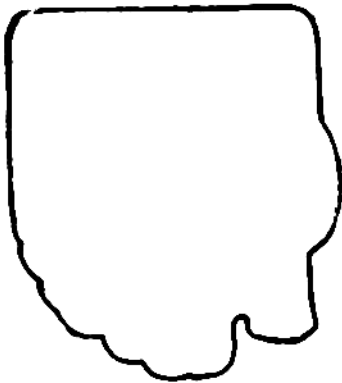

S. 1350



S. 1351



S. 1352



S. 1353



S. 1354



A) Einschnittwerkzeuge

S. 1355

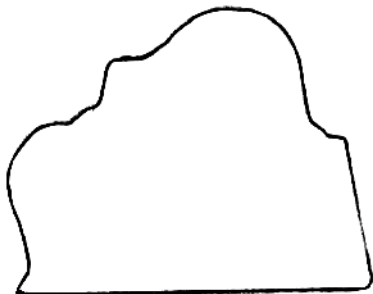

S. 1356

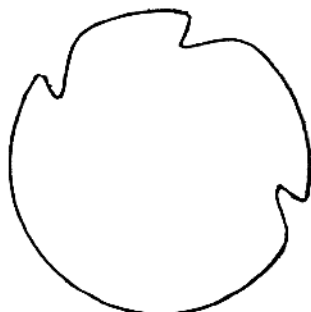

S. 1357



S. 1358

S. 1359

S. 1360

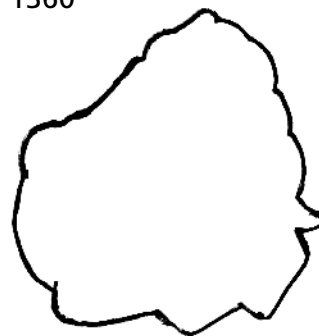

S. 1361



S. 1362

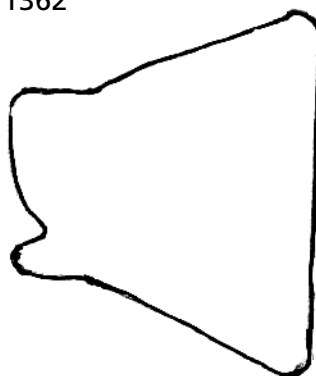

S. 1363

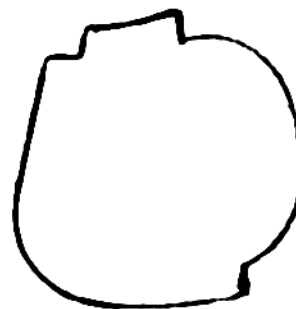

S. 1364

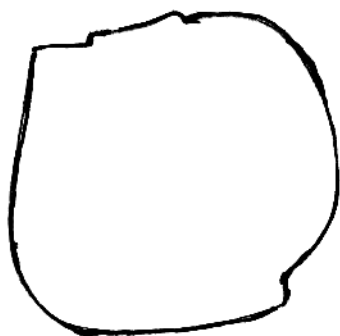

S. 1365



S. 1366

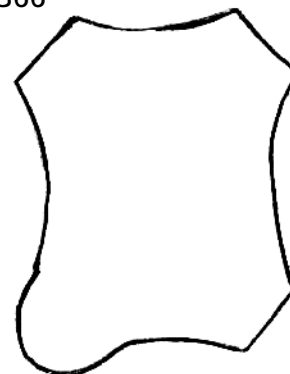

A) Einschnittwerkzeuge

S. 1367



S. 1368



S. 1369



S. 1370

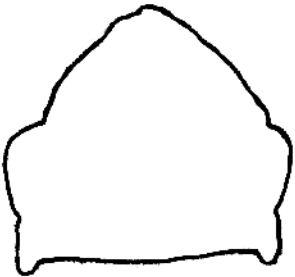

S. 1371

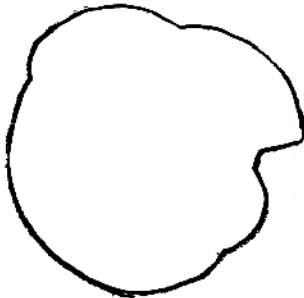

S. 1372



S. 1373

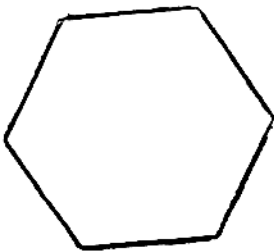

S. 1374

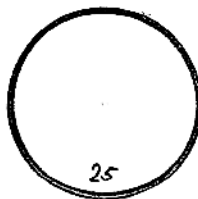

S. 1375

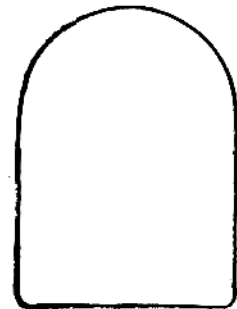

S. 1376

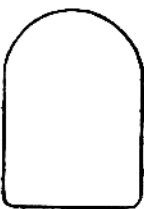

S. 1377

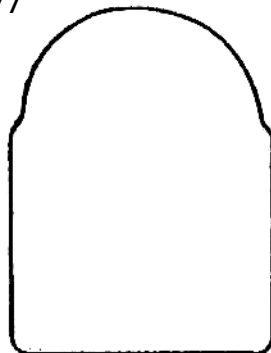

S. 1378

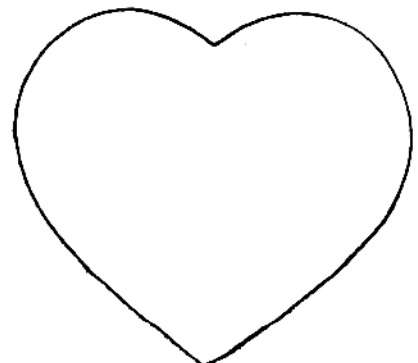

A) Einschnittwerkzeuge

S. 1379



S. 1380

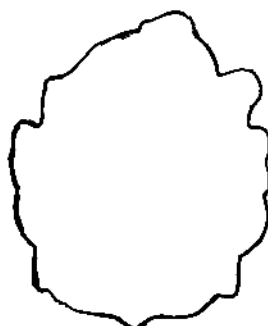

S. 1381

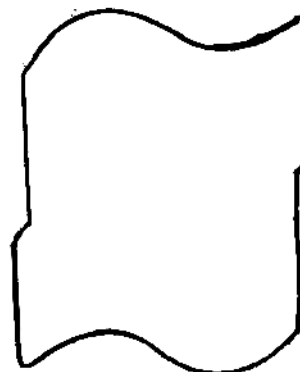

S. 1382

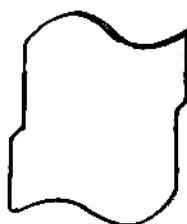

S. 1383

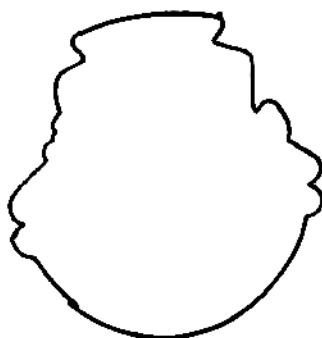

S. 1384

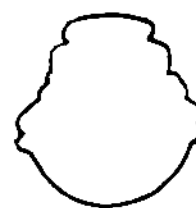

S. 1385

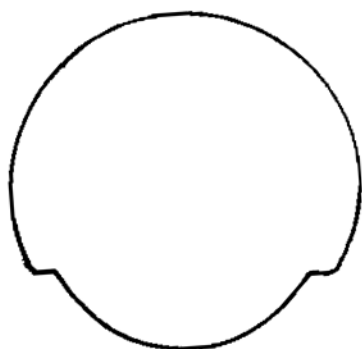

S. 1386

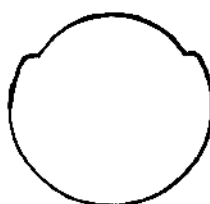

S. 1387



S. 1388



S. 1389

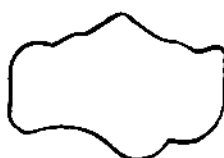

S. 1390

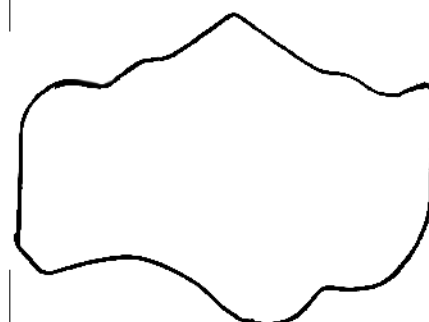

A) Einschnittwerkzeuge

S. 1391

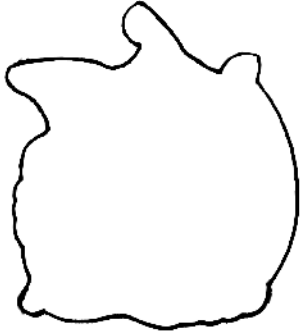

S. 1392



S. 1393

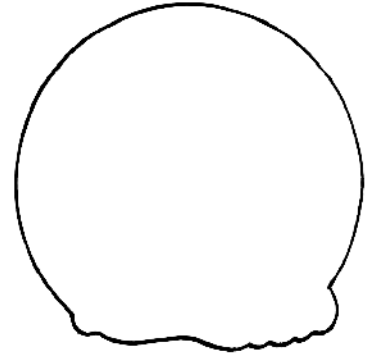

S. 1394



S. 1395

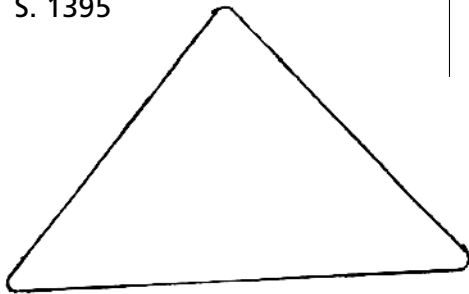

S. 1396

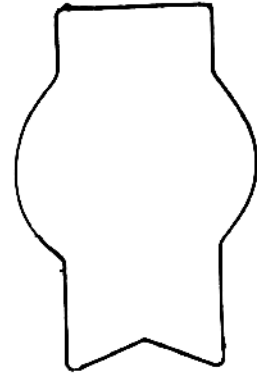

S. 1397

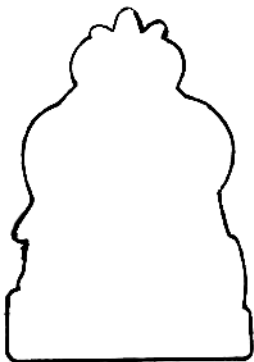

S. 1398



S. 1399



S. 1400

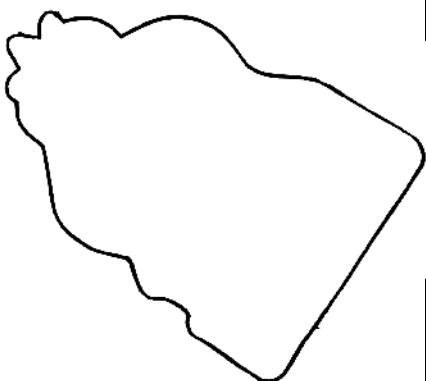

S. 1401

S. 1402

A) Einschnittwerkzeuge

S. 1023

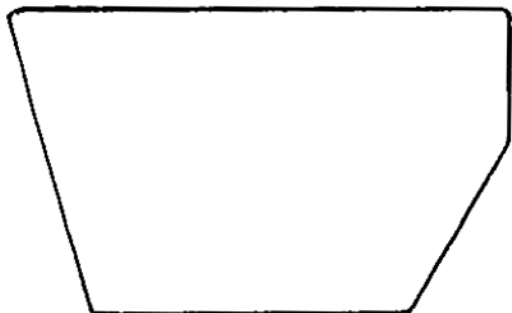

S. 1054

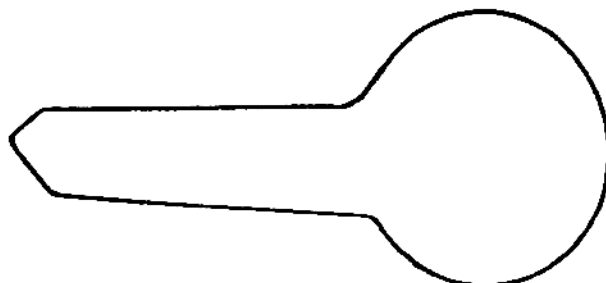

S. 1064

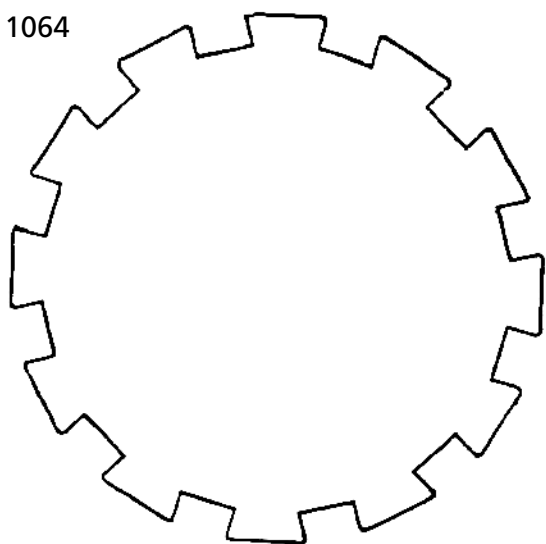

S. 1041

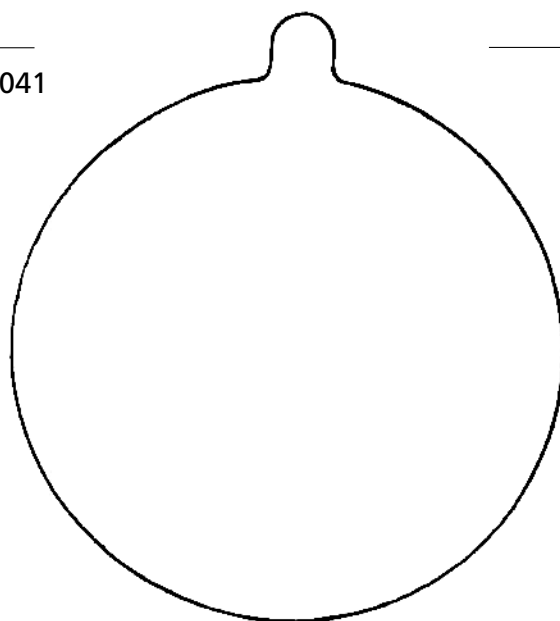

S. 1185B

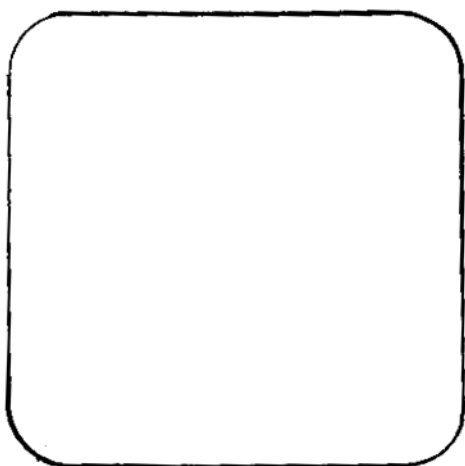

S. 1144

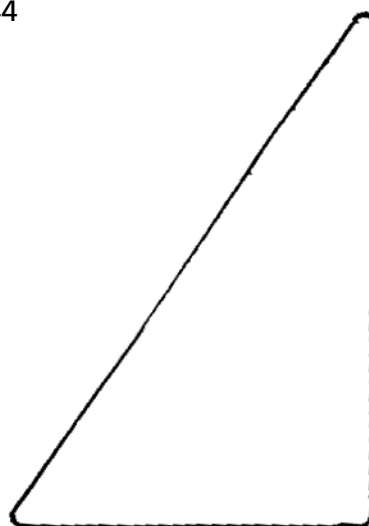

A) Einschnittwerkzeuge

S. 1159

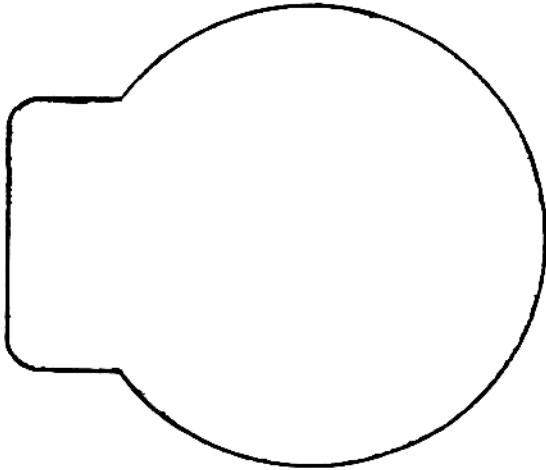

S. 1134

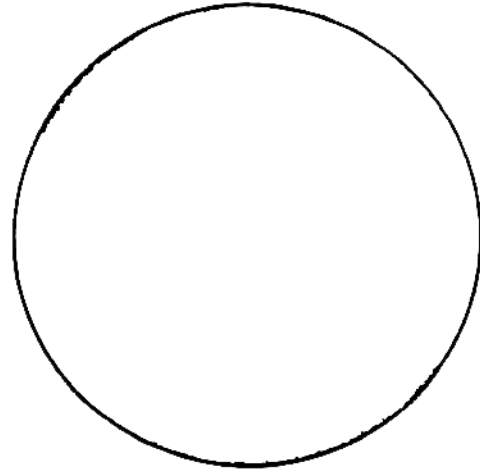

S. 1228

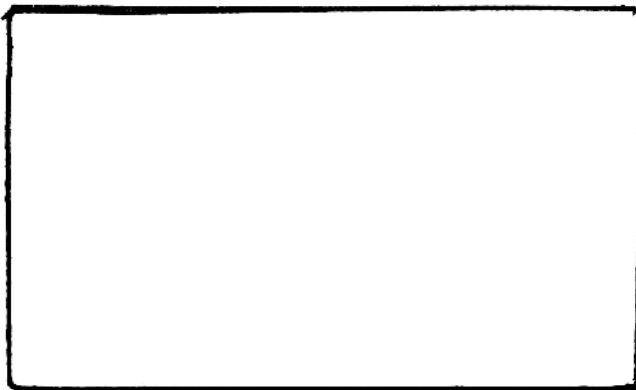

S. 1106

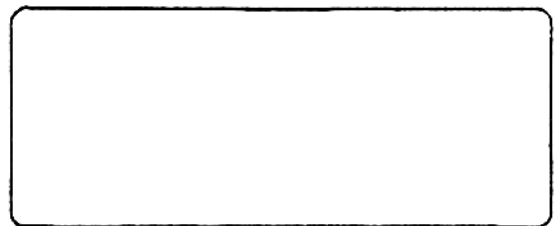

S. 1227

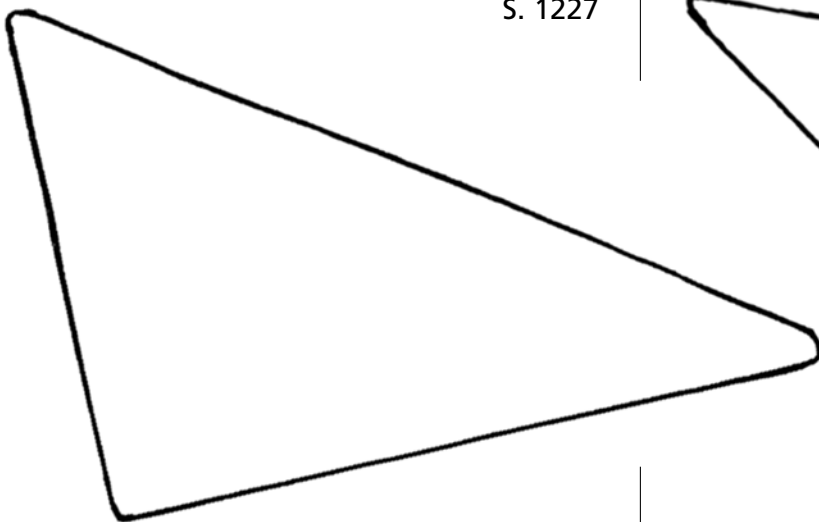

S. 1225

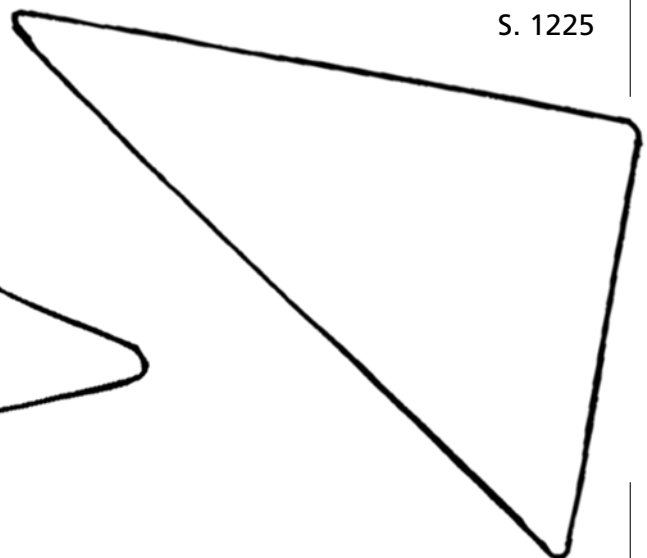

A) Einschnittwerkzeuge

S. 1024

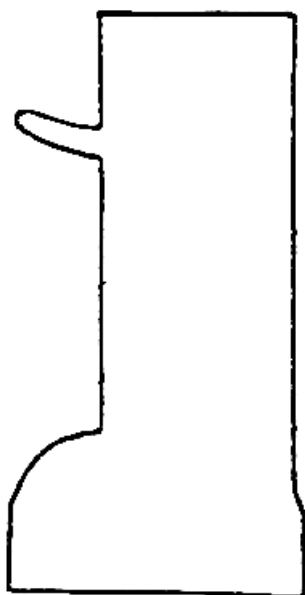

S. 1125

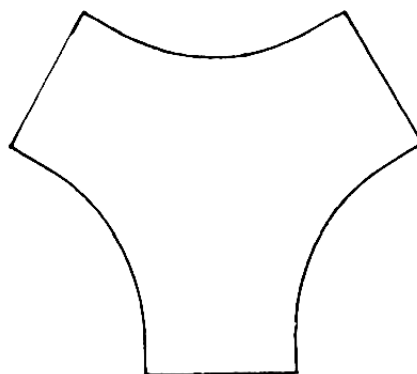

S. 1226

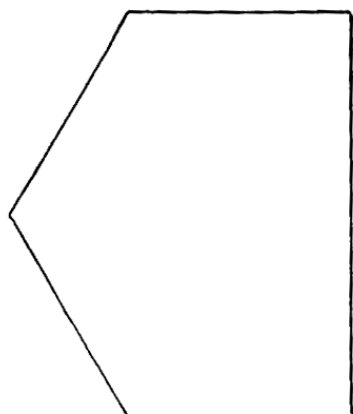

S. 1129





B) Parallelschnittwerkzeuge

Mit unseren Parallelschnittwerkzeugen steht Ihnen eine Vielfalt von Formen zur Verfügung.  
Kopieren Sie sich die Form und skizzieren Sie direkt auf der ausgesuchten Schnittform.



B) Parallelschnittwerkzeuge

S. 1051/1043

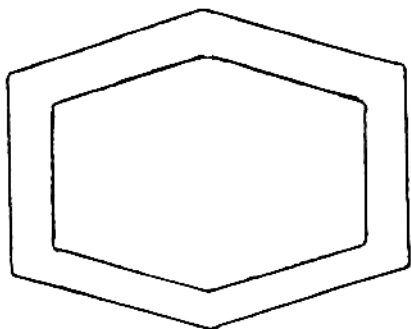

S. 1063/1062

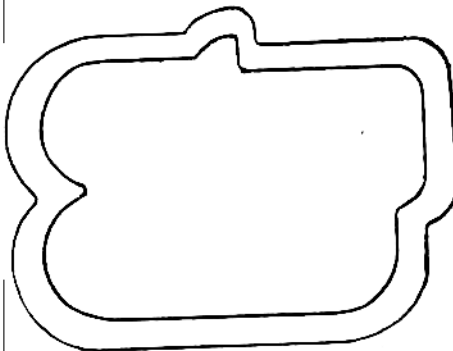

S. 1078/1079

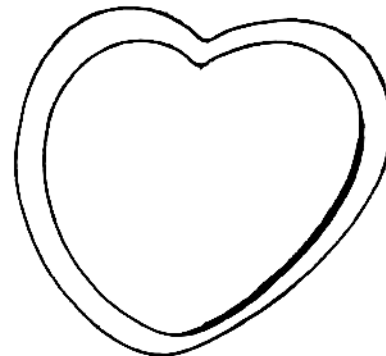

S. 1081/1082

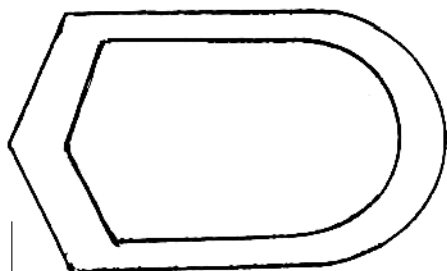

S. 1091/1092

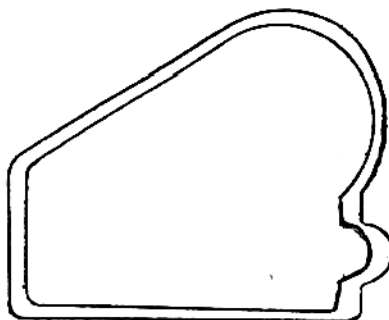

S. 1113/1114

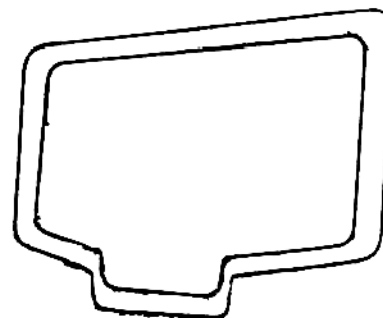

S. 1122/1123

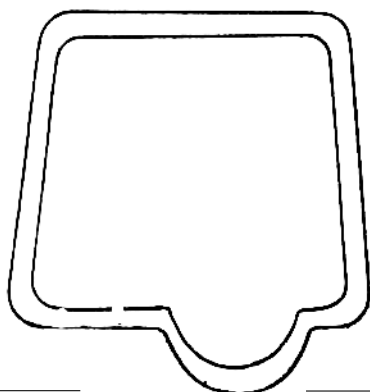

S. 1152/1154

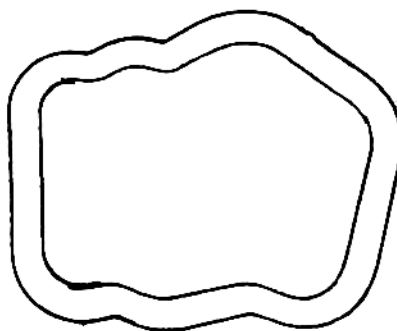

S. 1162/1164

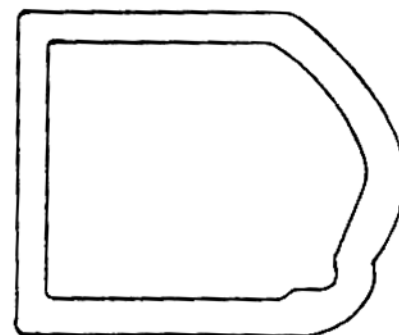

S. 1175/1177

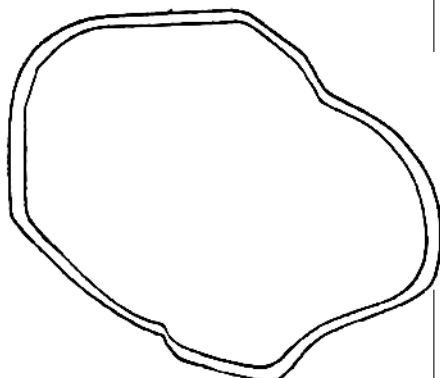

S. 1049/1089

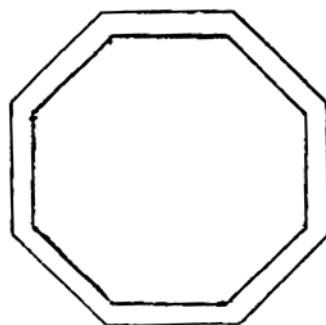

S. 1184/1183

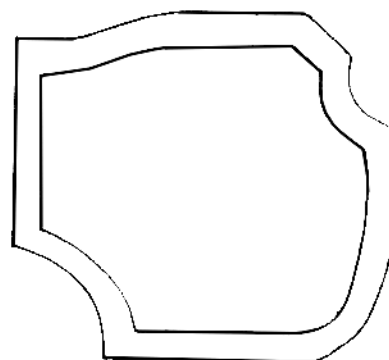

B) Parallelschnittwerkzeuge

S. 1186/1185

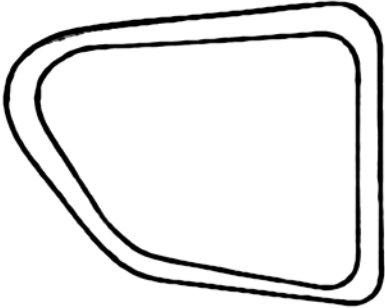

S. 1189/1190

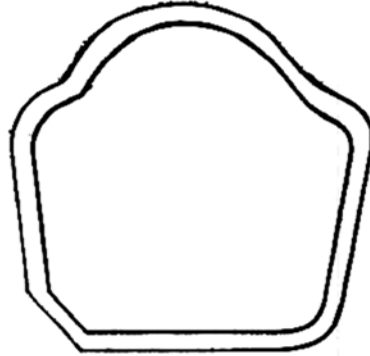

S. 1205/1206

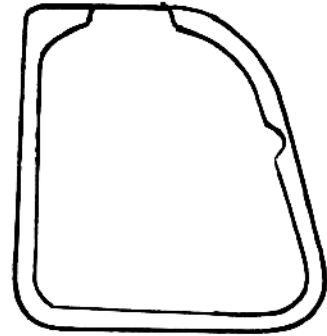

S. 1211/1212

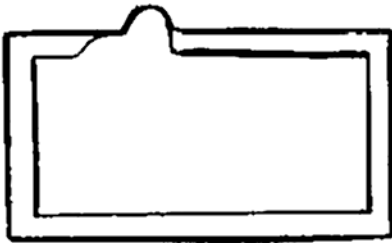

S. 1209/1210

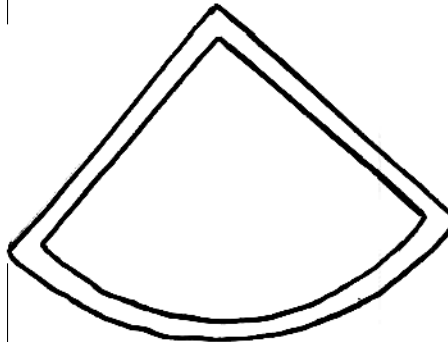

S. 1217/1218

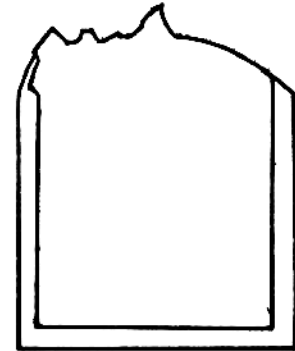

S. 1315/1316

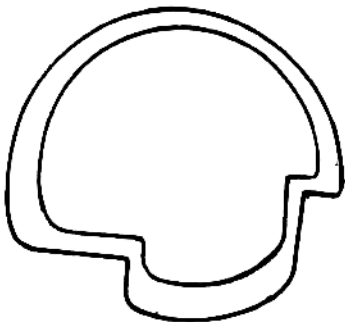

S. 1337/1338

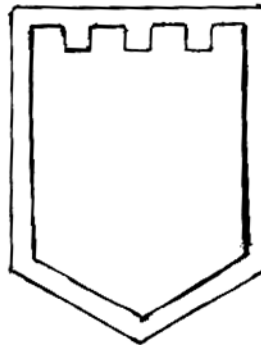

S. 1327/1328

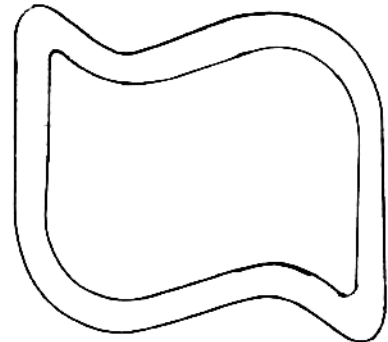

S. 1329/1330

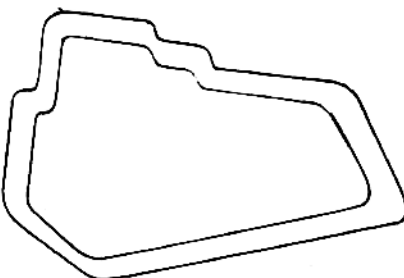

S. 1340/1341

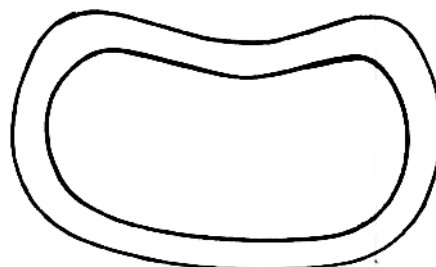

S. 1347/1348

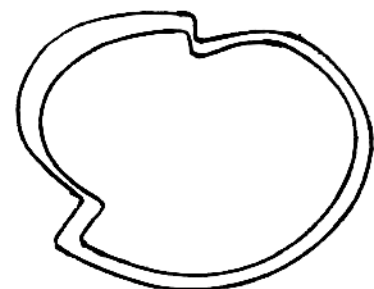

B) Parallelschnittwerkzeuge

S. 1363/1364



S. 1375/1377

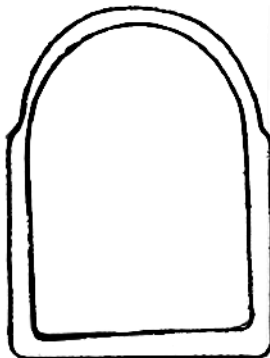

S. 1368/1367

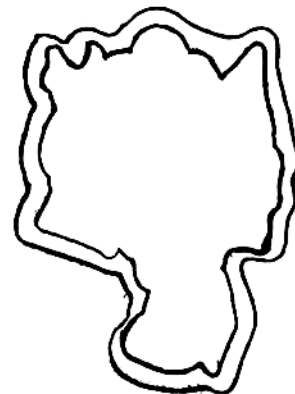

S. 1380/1381

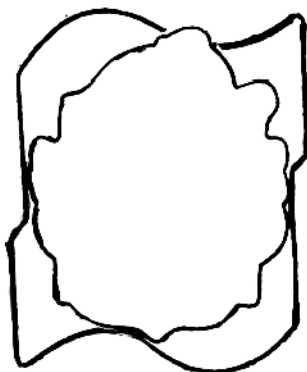

S. 1379/1382



S. 1383/1385

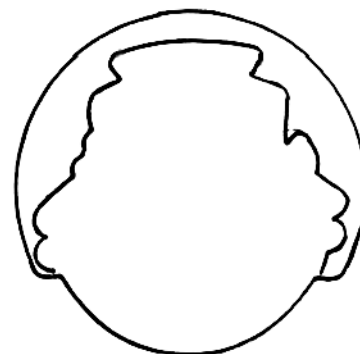

S. 1387/1390

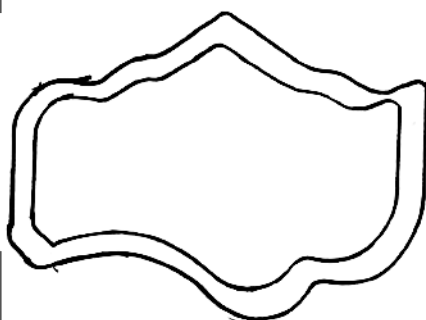

S. 1397/1400

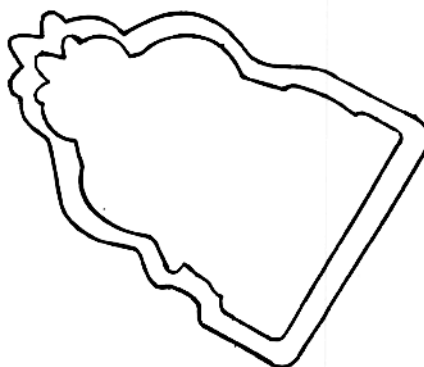

S. 1391/1393

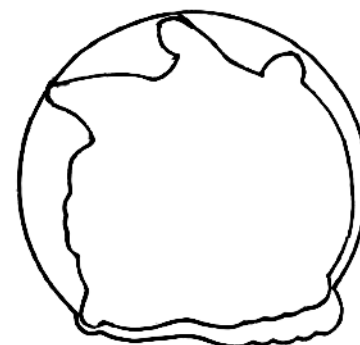

**Spezialitäten aller Art**

Ob Grossplaketten aus Bronze oder Kunststoff, Pins, Schlüssel-fundmarken und vieles mehr – freuen Sie sich auf ein weiteres künstlerisches Schmuckstück in Ihrer Sammlung.







## Mit Leidenschaft für Ihr Produkt

 Mit Freude am Detail pflegen wir Schweizer Handwerk und produzieren für Sie in höchster Qualität. Wir sind für Sie am Puls der Zeit und täglich auf der Suche nach technischen und gestalterischen Innovationen. Unsere Produkte mit beeindruckenden, haptischen und visuellen Eigenschaften werden Sie überzeugen. Fordern Sie uns heraus!

Prägetech AG

Binningerstrasse 104a · CH-4123 Allschwil · Telefon +41 61 481 00 22 · [info@praegetech.ch](mailto:info@praegetech.ch) · [www.praegetech.ch](http://www.praegetech.ch)